



DG TAXUD

ICS2 Release 2 Operational guidance for express consignments

ICS2

Date: 13/09/2022
Doc. Version: 1.10

Document Control Information

Settings	Value
Document Title:	ICS2 Release 2 Operational guidance for express consignments
Project Title:	ICS2
Document Author:	DG TAXUD ICS2 team
Project Owner:	DG TAXUD ICS2 team
Project Manager:	DG TAXUD ICS2 team
Doc. Version:	1.10
Sensitivity:	Public
Date:	13/09/2022

Document Approver(s) and Reviewer(s):

NOTE: All Approvers are required. Records of each approver must be maintained. All Reviewers in the list are considered required unless explicitly listed as Optional.

Name	Role	Action	Date
ECCG		Approve	
TCG		Review	

Document history:

The Document Author is authorized to make the following types of changes to the document without requiring that the document be re-approved:

- Editorial, formatting, and spelling
- Clarification

To request a change to this document, contact the Document Author or Owner.

Changes to this document are summarized in the following table in reverse chronological order (latest version first).

Revision	Date	Created by	Short Description of Changes
1.10	13/09/2022	DG TAXUD	Document updated with comments after the external review
1.00	24/06/2022	DG TAXUD	Document sent out for external review with economic operators and Member States representatives
0.60	16/06/2022	DG TAXUD	Document updated with further input/questions
0.50	06/05/2022	DG TAXUD	Document draft updated with further details and sent out for preliminary review before the next expert group in June
0.40	15/04/2022	DG TAXUD	Document draft updated with input during the expert group meeting
0.30	31/03/2022	DG TAXUD	Document updated after the second expert group discussions
0.20	10/03/2022	DG TAXUD	Document updated after the first expert group discussions
0.10	04/02/2022	DG TAXUD	Initial version

TABLE OF CONTENTS

1	INTRODUCTION	6
1.1	Purpose	6
1.2	Scope of the document	6
1.3	Target Audience	6
1.4	Structure of this document	6
1.5	Reference and applicable documents	8
1.6	Abbreviations and Acronyms	8
1.7	Definitions	10
1.8	General disclaimer	13
2	BACKGROUND	14
3	LEGAL BASIS	15
3.1	Legal background	15
3.2	Obligation to lodge ENS	15
3.3	Place to lodge ENS	15
3.4	Single / multiple filing	15
3.5	Specific waivers from the obligation to lodge an ENS	16
3.5.1	Territories for which ENS is needed	16
3.5.2	Items of correspondence	16
3.5.3	Goods on all means of transport passing through the territorial waters or the airspace of the customs territory of the ICS2 countries	16
3.5.4	Movement of military goods	17
3.5.5	Diplomatic mail	17
3.5.6	Intrinsic values consignments – no waiver for ENS lodgement	17
3.6	Registration of the declarant for ENS lodgement	17
3.7	Timelines	17
4	ROLES AND RESPONSIBILITIES	18
4.1	Economic operator roles	18
4.1.1	Express operator	18
4.1.2	Declarant	18
4.1.3	Supplementary declarant	18
4.1.4	Representative	18
4.1.5	Person filing	19
4.1.6	Carrier	19
4.1.7	House filer	19
4.1.8	Person notifying the arrival	19
4.1.9	Notify party	19
4.1.10	IT service provider	19
4.1.11	Consignor	19
4.1.12	Consignee	20
4.2	ICS2 Country roles	20
4.2.1	Addressed Member State (AMS)	20
4.2.2	Responsible Member State (RMS)	20
4.2.3	Involved Member State (IMS)	20
4.2.4	Member State of Control	20
4.3	Customs offices roles	20
4.3.1	Customs office of first entry (COFE)	20
4.3.2	Customs office of unloading	20

4.3.3	Customs office of presentation	20
5	ICS2 PROCESS DESCRIPTION.....	21
5.1	General ICS2 process overview	21
5.2	ICS2 R2 processes for express consignments.....	22
5.2.1	ENS filings lodged pre-loading.....	22
5.2.2	ENS filings lodged pre-arrival (as of R2)	24
5.2.3	ENS filings combinations	25
5.2.4	Split consignment.....	27
5.2.5	Re-entry.....	30
5.2.6	Referrals	31
5.2.7	Arrival notification (as of R2)	32
5.2.8	Presentation of goods to customs	32
5.2.9	Controls of goods by customs	33
5.2.10	Subsequent customs procedure.....	33
5.2.11	Amendments of an ENS filing	33
5.2.12	Invalidation of an ENS filing.....	34
5.2.13	Consult ENS (as of R2)	35
5.3	Non-standard express scenarios	35
5.3.1	Force majeure circumstances for flights not initially planned to stop in ICS2 countries territory – handled by express	35
5.3.2	Loose loaded flight / bulk loading	36
5.3.3	Re-entry of consignments into the territory of the ICS2 countries.....	37
7.	A presentation notification is sent to the Customs authorities' national presentation system where the goods are unloaded in Italy, FCO.	39
5.3.4	A transit/stop of Union goods to a 3 rd country	39
6	DATA REQUIREMENTS	40
6.1	Linking on ENS filings into an ENS	40
6.2	Data consolidation on master level	41
6.3	Definition of data elements	41
6.4	Missing and incorrect data elements.....	42
6.5	Poor data quality examples.....	43
6.6	Data consistency checks	44
7	TRANSITION FROM ICS2 R1 TO R2	45
8	BUSINESS CONTINUITY	46
9	QUESTIONS AND ANSWERS	47

TABLE OF TABLES

Table 1:	Reference documents	8
Table 2:	Abbreviations and acronyms	9
Table 3:	Definitions	12
Table 4:	Express ENS filings non-amendable data elements	34
Table 5:	Force majeure circumstances for flights not initially planned to stop in ICS2 countries territory - handled by express	36
Table 6:	Loose loaded flight / bulk loading	37
Table 7:	Re-entry of consignments in ICS2 countries – a single movement	38
Table 8:	Re-entry of consignments in ICS2 countries – two movements	38

Table 9: Stop of ICS2 country goods in a 3 rd country	39
Table 10: Unique linking key between F21 and F33	40
Table 11: Linking between the house consignments in the pre-loading and the pre-arrival ENS filings for express consignments	41
Table 12: Data elements definitions	42

TABLE OF FIGURES

Figure 1: ICS2 Process phases	21
Figure 2: F32 lodged in ICS2 HTI.....	22
Figure 3: Assessment complete notifications content for express pre-loading.....	23
Figure 4: Pre-loading and pre-arrival express ENS filings.....	24
Figure 5: Assessment complete notifications content for express pre-arrival	25
Figure 6: F32 + F30	25
Figure 7: F32 + F31	26
Figure 8: F32 + F33 + F21	26
Figure 9: Split consignment for express - COFE in different ICS2 countries.....	27
Figure 10: Split consignment for express - same COFE	28
Figure 11: Split consignment for express on air cargo general - COFE in different ICS2 countries.....	29
Figure 12: Split consignment for express on air cargo general – same COFE	30
Figure 13: Re-entry for express consignments.....	31
Figure 14: Express switch-over period and deployment windows and air carrier deployment window	45

1 INTRODUCTION

1.1 Purpose

All express consignments transported by air entering or transiting the EU, Switzerland, Norway and Northern Ireland (ICS2 countries) must be covered by an Entry Summary declaration (ENS) to be lodged in two phases:

- a minimum set of pre-loading data (PLACI data set) lodged in ICS2 system before the goods are loaded on the means of transport, and
- a complete ENS, lodged before the arrival of the goods.

This document provides operational guidance to the involved stakeholders for the entry processes implemented within the ICS2 system.

This guidance also forms an integral part of the overall ICS2 implementation guidance compendium.

1.2 Scope of the document

This document provides an operational guidance for the express operators and air carriers on the processes implemented within the ICS2 and the operational environment of the involved stakeholders.

The scope of the guidance is limited to ICS2 Release 2. This guidance covers:

- explanation of the legal basis and requirements for the entry process;
- description of the roles and responsibilities of the customs authorities and the economic operators stakeholders;
- explanations of express flows and business process;
- explanations of the ICS2 processes.

1.3 Target Audience

The intended audience for this document are:

- the representatives of the express operators;
- the representatives of the air carriers;
- the representatives of the ICS2 countries;
- any person involved in the ICS2 project;
- any person being involved in the customs formality for the entry of goods for express consignments.

1.4 Structure of this document

The present document contains the following chapters:

- **Chapter 1 – Introduction:** describes the scope and the objectives of the document;
- **Chapter 2 – Background:** describes the history of the implementation of security and safety measures and systems;
- **Chapter 3 – Legal basis:** describes the legal requirements for the lodgement of ENS filings;
- **Chapter 4 – Roles and responsibilities:** describes the actors involved and their roles and responsibilities;
- **Chapter 5 – ICS2 Process :** describes the ICS2 business processes relevant for the express operators;
- **Chapter 6 – Data requirements:** elaborates details for the data elements meaning, values and data quality;
- **Chapter 7 – Transition from ICS2 R1 to R2**Erro! A origem da referência não foi encontrada.: describes the principles to be followed for the transition from ICS2 R1 to R2 applicable to the express sector;
- **Chapter 8 –Business continuity:** provides reference to the document specifying the procedures to be followed in case of detected unavailability;

- **Chapter 9 – Questions and answers:** lists the responses to raised questions.

1.5 Reference and applicable documents

Ref.	Title	Reference	Version	Date
R01	ICS2 Harmonised Trader Interface Specifications	ICS2-HTI	2.02	23/05/2022
R02	ICS2 Business continuity plan for Economic operators	ICS2-BCP-EO	1.10	10/06/2022
R03	REGULATION (EU) No 952/2013 OF THE EUROPEAN PARLIAMENT AND OF THE COUNCIL of 9 October 2013 laying down the Union Customs Code	UCC		09/10/2013
R04	COMMISSION DELEGATED REGULATION (EU) 2015/2446 of 28 July 2015 supplementing Regulation (EU) No 952/2013 of the European Parliament and of the Council as regards detailed rules concerning certain provisions of the Union Customs Code	UCC-DA		28/07/2015
R05	COMMISSION IMPLEMENTING REGULATION (EU) 2015/2447 of 24 November 2015 laying down detailed rules for implementing certain provisions of Regulation (EU) No 952/2013 of the European Parliament and of the Council laying down the Union Customs Code	UCC-IA		24/11/2015
R06	EU guidance on air cargo security referral protocols for ICS2 ¹		1.15	24/01/2020
R07	Vienna Convention on diplomatic relations of 18 April 1961			18/04/1961
R08	Vienna Convention on consular relations of 24 April 1963			24/04/1963
R09	New York Convention of 16 December 1969 on special missions			16/12/1969
R10	COMMISSION IMPLEMENTING REGULATION (EU) No 2015/1998 of 05 Nov 2015 (effective 01 Feb 2016) laying down detailed measures for the implementation of the common basic standards on aviation security.	AVSEC measures		05/11/2015
R11	WCO SAFE Framework of standards	SAFE Framework		June 2005
R12	Joint WCO-ICAO Guiding Principles for Pre-Loading Advance Cargo Information (PLACI)	JWGACI		First edition
R13	Guidance document on customs formalities on entry and import into the European union			2018

Table 1: Reference documents

1.6 Abbreviations and Acronyms

Abbreviation/Acronym ICS 2	Definition
AC	Assessment Complete
ACC3	Air cargo or mail carrier operating into the EU from a third country airport
AEO	Authorized Economic Operator
AEOS	Authorised Economic Operator authorised for security and safety
AMS	Addressed Member State
AN	Arrival Notification

¹ The EU guidance on air cargo security referral protocols will be updated for ICS2 R2.

AVSEC	Aviation security
COFE	Customs office of first entry
CR	Common Repository
DNL	Do Not Load
ENS	Entry Summary Declaration
EO	Economic operator
EORI	Economic Operators Registration and Identification number
EU	European Union
HAWB	House air waybill
HC	House consignment
HRCM	High Risk Cargo and Mail
HTI	Harmonised Trader Interface
ICAO	International Civil Aviation Organization
ICS Phase 1	Import Control System Phase 1
ICS2	Import Control System 2
IE	Information exchange
IMS	Involved member state
JWGACI	Joint ICAO WCO Working Group on Advance Cargo Information
LRN	Local Reference Number
MAWB	Master air waybill
MRN	Master Reference Number
MS	Member State
NES	National entry system
NSD	National service desk
PLACI	Pre-loading advance cargo information
RA	Risk analysis
RFI	Request for Information
RFS	Request for Screening
RMS	Responsible member state
STI	Shared Trader Interface
STP	Shared Trader Portal
UCC	Union Customs Code [Regulation (EU) No 952/2013 of the European Parliament and of the Council of 9 October 2013 laying down the Union Customs Code]
UCC-DA	Commission Delegated Regulation (EU) 2015/2446 of 28 July 2015 supplementing UCC as regards detailed rules concerning certain provisions of the UCC
UCC-IA	Commission Implementing Regulation (EU) 2015/2447 of 24 November 2015 laying down detailed rules for implementing certain provisions of the UCC
UN/LOCODE	United Nations / Location Code for trade and transport
UUM&DS	Uniform User Management and Digital Signature
WCO	World Customs Organization

Table 2: Abbreviations and acronyms

1.7 Definitions

Term	Definition
AEO(S)	Authorized economic operator is a status granted to an EO as a concept that is based on a partnership between customs and business. It is granted by one MS and recognised by customs authorities in all MS. AEO(S) status can be granted to EO's, which meet the following criteria: compliance with customs legislation and taxation rules and absence of criminal offences related to economic activity, appropriate record keeping, financial solvency and appropriate security and safety measures.
Air pre-loading risk analysis	Air pre-loading risk analysis is a limited security risk analysis by the customs aimed to identify potential risk of (improvised) explosive device entering into the air cargo supply chain posing threat to the civil aviation (aka 'bomb-in-a-box' risk assessment).
Arrival notification / AN	Arrival notification is a message sent from the operator of a sea-going vessel or of an aircraft (mandatory in air and maritime mode of transport only) entering the territory of the ICS2 countries. It shall notify the arrival of the means of transport to the Customs office of first entry. No Arrival notification is expected for ICS2 countries to any subsequent customs office on the route of the means of transport once it has entered the ICS2 countries territories.
Common repository / CR	The ICS2 Common Repository is a system component of ICS2 managing the ENS lifecycles, the risk analysis processes and the analytical services.
Complete ENS	Complete ENS means an ENS containing all required data particulars required by the legislation per specific mode of transport or business model. The complete ENS can be represented either by a full ENS filing or all necessary partial ENS filings that together contain all required data particulars.
Control notification	Control notification is a message sent by the competent customs authorities to the person, who is presenting the goods, about the decision that some of the goods (or all) need to be physically presented for customs controls.
CS/RD2	The CS/RD2 IT application is a DG TAXUD application, which implements the services to provide and validate reference data required by the ICS2 STI and CR processes.
Entry summary declaration / ENS	Entry Summary Declaration (ENS) means the act whereby a person informs the customs authorities, in the prescribed form and manner and within a specific time limit that goods are to be brought into the ICS2 countries.
ENS filing	ENS filing means either partial or full ENS data set required by the legislation per specific mode of transport or business model.
ENS lifecycle	The ENS lifecycle is a term used to reference to the end-to-end process of the ENS statuses, from its filing until the final state of presentation, and where relevant performance of customs controls and documentation of results.
Express consignment	An express consignment means an individual item conveyed by or under the responsibility of an express carrier.
Goods item	Goods items (articles in items) which are to be classified under different HS-codes.
Harmonized System (HS)	Harmonized System for the Classification of Goods of the World Customs Organization
House air waybill (HAWB)	A house air waybill (HAWB) is a form of an air waybill that is issued by a freight forwarder, express operator or an agent to its customer.
House consignment / HC	In ICS2 this term refers to a created entity based on the information about a consignment from a house level transport contract issued by a freight forwarder, non-vessel operating common carrier or agent to its direct contracting party (customer).

House consignment item	Contained items of a House consignment which require an own House consignment goods item declaration.
House consignment goods item	The House consignment goods item level is a sub-level to the House consignment level for the declaration of the different goods contained in the House consignment. Goods items which are to be classified under different HS-codes require a separate goods item declaration within the House consignment declaration of a F32 ENS filing. The data elements of the House consignment item level contain information that originate from different positions in the transport document referred to in the current House consignment.
High Risk Cargo and Mail Screening (HRCM screening)	High Risk Cargo and Mail Screening (HRCM screening) is a notification communicated by the customs authority of the RMS to the person filing (and the carrier under certain conditions) that the goods concerned shall need to be screened as a high risk cargo and mail, in accordance with the point 6.7.3 of the Annex to Commission Decision C (2010) 774 of 13 April 2010, before being loaded on board of an aircraft destined to arrive to an ICS2 country.
ICS2 countries	These are the countries which are part of the ICS2 project (applying EU customs legislation in the context of entry formalities and ICS2) including the EU Member States, Switzerland, Norway and Northern Ireland (as part of the implementation of the Northern Ireland protocol).
Master Air Waybill (MAWB)	Master air waybill (MAWB) is a form of an air waybill that is issued by the carrier to its direct contractual party (customer).
Master consignment	In ICS2 this term refers to a created ENS entity based on the information about a consignment from a master level transport contract issued by a carrier to its direct contracting party.
Master level ENS filing	This is a partial filing, which contains information derived from a MAWB or Mbol, depending on the mode of transport.
Master Reference Number	Master Reference Number means the registration number allocated by the competent customs authority to declarations or notifications. The MRN is assigned for each ENS filing registered by the customs authorities and communicated back to the person filing.
Person filing	Person filing means any person that submits to the customs authority ENS filing in its complete or partial content and other notifications in the prescribed form and manner. This person can be any person that issues bill of lading or air waybill and can be either carrier, NVOCC (i.e. freight forwarder), or any person identified by the legal provisions obliged to submit required particulars of ENS to the customs and can include postal operator, consignee stipulated in the lowest bill of lading. Person filing also includes representative of any of the persons mentioned above that submits the ENS filing in its complete or partial content to the customs authority on behalf of the person that it is representing.
PLACI data	Pre-loading advance cargo information (PLACI)/Minimum data set 7+1 comprise consignor name and address, consignee name and address, number of packages, gross weight, goods description and transport reference number (HAWB/MAWB).
PLACI risk analysis	In the case of air cargo pre-loading, the risk analysis process is triggered at the moment of the receipt of the required minimum 7+1 PLACI data. The process is only focused on the detection of an immediate risk to aviation posed by an assembled improvised explosive device (IED) or improvised incendiary device (IID) aka 'bomb in the box' introduced on board an aircraft that could lead to the destruction of the plane and/or the loss of lives. The PLACI analysis is therefore not intended to assess or confirm the effectiveness of aviation security measures applied by the supply chain actors nor measure the compliance with these regulations or duplicate them. In the case of air transport (general cargo, postal consignments, express consignments), the pre-loading risk analysis may identify security and safety risks other than the one described above. While this result is taken into account in the further process of risk analysis at the pre-arrival

	stage, it does not stop the goods to be loaded on the plane at the point of departure into the EU.
Pre-arrival risk analysis	Security and safety risk analysis performed prior to the arrival of the goods into the territory of the ICS2 countries.
Presentation	Presentation to customs means notifying to customs that goods under customs supervision have arrived and are physically available for a (potential) control at the customs office of presentation.
Presentation notification	Presentation notification is a message required from the economic operator after unloading of the goods to be sent to the national presentation system (not to ICS2 HTI).
UUM&DS	The Uniform User Management and Digital Signatures (UUM&DS) is a unique trader interface implementing secure authorized access for Economic Operators and their representatives accessing European Customs Information Systems by enabling the use of Digital Signatures Services by these systems.

Table 3: Definitions

1.8 General disclaimer

This guidance document is of an explanatory and illustrative nature. Customs legislation takes precedence over the content of this document and should always be consulted. The authentic texts of the EU legal acts are those published in the Official Journal of the European Union. There may also be national instructions.

2 BACKGROUND

Safeguarding the global supply chain is critical. Security measures must protect the involved stakeholders from any risks that could endanger lives, cause losses – in short, security measures shall eliminate all lethal threats.

After the Yemen air cargo security incident in 2010, the aviation ACC3 regime was put in place. The ACC3 (Air cargo or mail carrier operating into the EU from a third country airport) regime, established by the Commission Implementing Regulation (EU) No 2015/1998 and Decision C(2015) 8005 [R10], stipulates that cargo and mail entering the EU on an aircraft must be controlled according to the EU air cargo screening obligations unless it comes from an airport located in a country exempted from these rules.

EU Customs Security Legislation was implemented in 2011, giving the customs authorities of the EU Member States a legal responsibility to ensure that a risk analysis is carried out and finalized primarily for security and safety purposes as an additional layer to the ACC3 regime. The next generation EU security legislation is built upon the experiences and findings obtained from many international pilots and projects on the security and safety issues.

Internationally, the PLACI principles consist of the pre-loading advanced air-cargo information (PLACI data set) submission and three referral types for air-cargo are in place. These principles were taken on board of the WCO SAFE Framework of Standards in 2015 [R11].

The EU Customs pre-arrival security and safety programme is supported by the Import Control System 2 (ICS2). The implementation of this system represents a core EU customs instrument for managing entry security and safety border controls.

ICS2 system will become operational in three releases. This approach enables the economic operators to begin declaring safety and security ENS data to ICS2 based on phased requirements and the type of services they provide:

- **ICS2 Release 1 (15 March 2021)**

The pre-loading advanced cargo information (PLACI) is used for cargo and mail security risk assessment. Where necessary a competent ICS2 country customs authority may issue risk mitigating referrals.

Those procedures need to be implemented by the express operators, as indicated also in WCO SAFE framework of standards [R11].

The competent ICS2 countries customs authority will inform express operators about the completion of the pre-loading risk analysis by providing an assessment complete notification (AC).

- **ICS2 Release 2 (1 March 2023)**

The express operators bringing consignments into the ICS2 countries, shall provide the complete ENS for all goods in express consignments in air traffic to the ICS2.

The competent ICS2 countries customs authority will inform the express operators about the completion of the pre-arrival risk analysis by providing an assessment complete notification (AC). There could be controls notified to the express operators to be performed either at COFE or Customs office of unloading.

The carriers operating the aircraft bringing the goods need to notify the arrival of the aircraft at the Customs office of the first entry by lodging an Arrival notification to the ICS2 or to a national arrival system.

The presentation notification is lodged to the national customs presentation system where the goods are unloaded from the means of transport.

- **ICS2 Release 3 (1 March 2024)**

In addition to the scope of ICS2 Release 2 for the express operators, ICS2 Release 3 introduces the lodgement of ENS filings for express consignments carried on road mode of transport.

3 LEGAL BASIS

The legal background of ICS2 is elaborated in the “Guidance document on customs formalities on entry and import into the European union” [R13] and can be found [here](#).

3.1 Legal background

The main legal provisions governing the entry formalities are laid down in the Union Customs Code (UCC) – Regulation of the European Parliament and of the Council (EU) No 952/2013 and its Implementing and Delegated Acts ([R04], [R05], [R06]).

The legal base for the requirement to lodge an ENS is defined in Article 127 of UCC [R04]. The intention of this customs formality is to obtain cargo & mail information in advance (before the goods enter the customs territory of the ICS2 countries), for safety & security risk analysis performed by the competent customs authority.

3.2 Obligation to lodge ENS

The obligation to lodge the ENS is, in general, with the carrier being responsible for the transport of the goods into the territory of the ICS2 country. The ENS can instead be lodged by the importer or consignee of the goods or by any person who is able to present or has presented the goods to customs [Article 127 (4)] [R03]. In practice, the vast majority of the ENS’s for the express consignments will be lodged by the express operators.

In cases, where not all particulars required for an ENS are provided to the carrier, other persons holding those particulars may be required to provide those particulars to customs [UCC, Article 127 (6)] [R03].

Additionally, the arrival notification has to be lodged by the express carriers for the arrival of their own operated aircrafts.

3.3 Place to lodge ENS

In general, the ENS shall be lodged at the customs office of first entry [Article 127 (3) UCC] [R03].

The PLACI ENS filing shall be lodged to the MS where the goods most likely arrive first to the customs territory of the ICS2 countries.

3.4 Single / multiple filing

The ENS can be lodged either in the form of a single ENS filing containing all required ENS particulars or by more than one ENS filing. The latter one applies where the party, legally responsible to lodge an ENS, does not have all required particulars available to lodge timely a complete ENS in a single file.

The ENS related information for the express consignments is lodged in two phases.

In the pre-loading phase one type of ENS filing is lodged by the express operator:

- ENS filing based on Annex B DA column F32: contains the minimum pre-loading information (PLACI).

In the pre-arrival phase several types of ENS filings can be used depending on how the express consignments will be transported:

- ENS filing based on Annex B DA column F30: used for the express consignments transported by the express operator on their own aircrafts. F30 contains the full ENS data.
- ENS filing based on Annex B DA column F31: used for the express consignments transported by an air cargo general carrier. It contains the full ENS data.
- ENS filing based on Annex B DA column F21: used for the express consignments transported by an air cargo general carrier. It contains the master level ENS data.
- ENS filing based on Annex B DA column F33: used for the express consignments transported by an air cargo general carrier. It contains the house level ENS data and is lodged in combination with F21.

The detailed requirements for all ENS filing types are available in ICS2 HTI Information Exchange Specifications [R01].

3.5 Specific waivers from the obligation to lodge an ENS

The detailed provisions of the EU customs legislation related to waivers and exceptions are in UCC and the related acts [R03], [R04], [R05].

3.5.1 Territories for which ENS is needed

Whether there is an obligation to lodge an ENS or a waiver from the obligation applies depends on two factors:

1. The goods are not entering the customs territory of the Union from outside (obligation to lodge an ENS from Article 127 (1) UCC does not apply at all) or are entering the customs territory of the Union from a country that has entered a bilateral agreement with the Union (actually Switzerland and Norway). In those cases either Article 127 (1) UCC does not apply or the obligation is directly waived in accordance with Article 127 (2) UCC.
2. Specific goods (i.e. electrical energy) or goods fulfilling specific requirements (i.e. personal baggage of a traveller) in accordance with Article 104 UCC-DA.

There is a list of territories which are classified as part of the territory of the ICS2 countries – hence, when goods arrive from these territories to the main land Union territory without stopping to 3rd countries territory then no ENS is needed. Respectively, when goods arrive from 3rd countries to these territories, then ENS must be provided (Article 127 (1) UCC applies).

Article 4, UCC lists all countries and territories considered as part of the Union customs territory. The Canary Islands, Aland Islands, Mount Athos, Azores and Madeira are part of the Union customs territory and an ENS is therefore not required when goods arrive from there since Article 127 (1) UCC does not apply when no stop in a third country was made in between. Respectively, when goods arrive from 3rd countries there an ENS must be filed.

What parts of France are also parts of the Union customs territory is defined in UCC Article 4 10th indent.

The UCC refers to Part 4 of the Treaty of the Functioning of the EU (TFEU) to elaborate which parts of the French territory are excluded. This part 4 refers to Annex II of the TFEU where the exclusions are listed.

The French overseas departments, countries and territories require distinction. The following are excluded from the Union customs territory and transport from there into the EU requires generally an ENS where no other waiver depending on the goods applies (point 2. from above):

- New Caledonia and Dependencies
- French Polynesia
- French Southern and Antarctic Territories
- Wallis and Futuna Islands
- Saint Pierre and Miquelon
- Saint-Barthélemy

All other territories of the French Republic are part of the customs territory of the Union and an ENS is therefore not required since Article 127 (1) UCC does not apply when no stop in a third country was made in between.

3.5.2 Items of correspondence

The items of correspondence do not require to be covered by an ENS. The term ‘items of correspondence’ covers letters, postcards, braille letters and printed matter, containing only documents and not containing any goods and not liable to any customs duties. The explanation of the term “items of correspondence” is defined in Article 1 (24, 26) UCC DA [R04]). Any letter post item containing goods needs to be covered by an ENS. It is therefore important to obtain the information that an item contains correspondence already at the time of posting from the person sending the item.

3.5.3 Goods on all means of transport passing through the territorial waters or the airspace of the customs territory of the ICS2 countries

No ENS is required for goods on all means of transport which are passing through the territorial waters or the airspace of the territory of the ICS2 countries without stopping within this territory.

3.5.4 Movement of military goods

The waiver from the obligation to lodge an ENS as referred to in Article 104 (1) (h), UCC DA [R04] applies to all military authorities of a NATO member country when the goods entering the Union are covered by a NATO form 302.

The waiver from Article 104 (1) (i), UCC DA [R04] does not apply to third country military authorities since they are solely applicable to the military authorities of a MS of the European Union. Third country military authorities, even NATO members, are not in charge of the military defence of a MS of the European Union. Only military authorities of MS can be in that role. The express carrier can omit the ENS where weapons or military equipment are transported on behalf of a military authority of a MS of the European Union and the transport is solely performed for that military authority, meaning that no other consignments are transported on the same means of transport. The direct contracting party has to be the military authority of a MS.

If the military goods can be transported on a means of transport with other types of general goods (non-military goods)/consignments should be legally defined by each ICS2 country.

3.5.5 Diplomatic mail

The waiver from the obligation to lodge an ENS also applies for the goods which are pursuant to the Vienna Convention on diplomatic relations of 18 April 1961 [R07], the Vienna Convention on consular relations of 24 April 1963 [R08], other consular conventions or the New York Convention of 16 December 1969 [R09] on special missions.

3.5.6 Intrinsic values consignments – no waiver for ENS lodgement

The waiver for consignments with an intrinsic value not exceeding 22 Euros does not apply anymore for ICS2 operations. Hence, it follows that all consignments where no other waiver applies have to be covered by an ENS filing.

3.6 Registration of the declarant for ENS lodgement

An economic operator who wants to perform customs formalities in the ICS2 countries needs to be registered with customs. The registered EO is assigned an EORI number, which they use for all communication with customs for identification.

The economic operators, established in the EU countries, need to apply for EORI registration in the MS of establishment. The economic operators, established in a third country, should apply for it in the EU Member State where they first take up business operations or where they intend to operate the relevant facilities. One legal entity can apply for exactly one EORI number only.

3.7 Timelines

In case of transport by air, the PLACI ENS filing shall be lodged as early as possible as per Article 106 (1) UCC DA [R04]. The term 'as early as possible' means that the ENS is to be lodged as soon as all required particulars of the ENS are available to the person filing at the latest prior to loading.

The complete pre-arrival ENS shall be lodged within the time limits defined in the UCC:

- For flights with a duration less than four hours from the last airport outside of the customs territory of the ICS2 countries – at the latest at the time the aircraft takes off;
- For flights with a duration of four hours or more – at the latest four hours prior to arrival of the aircraft at the first airport in the territory of the ICS2 countries.

The timelines do not apply in case of *force majeure* (Article 111, UCC DA).

If the required ENS data have not been submitted to ICS2, the ENS will have to be submitted at the latest at the presentation of the goods. The goods will not be released for any subsequent customs procedure before the entry formalities are completed. Each ICS2 country can decide to impose penalties to the economic operators for not completing the ENS formalities within the legally defined deadlines.

4 ROLES AND RESPONSIBILITIES

4.1 Economic operator roles

4.1.1 Express operator

An operator providing integrated services of expedited/time-definite collection, transport, customs clearance and delivery of parcels whilst tracking the location of, and maintaining control over, such items throughout the supply of the service. This economic operator is authorized to perform customs clearance procedure. Any party that is only partially involved in the provision of such integrated services is not considered an express carrier but a party providing freight forwarding services.

4.1.2 Declarant

The declarant in this context is the person lodging an ENS in his or her own name or the person in whose name an ENS is lodged. The declarant is legally responsible for the timely lodgement within the legal deadlines and the accuracy of the content of the ENS.

The carrier shall lodge the ENS as per Art. 127(4) UCC. However, any other legal entities such as the importer, consignee or any other person in whose name or on whose behalf the carrier acts (Art. 127(4)(a) UCC) can also lodge the ENS. The lodgement of the ENS can be required from any person who is able to present the goods or have them presented to customs (Art. 127(4)(b) UCC) or any of the other persons specified in the DA in accordance with paragraph Art. 127(6) UCC. Whoever of these persons that submits the ENS is deemed to be the (ENS) declarant (Art. 5(15) UCC) shall have an EORI number (Art. 9 UCC).

As per the functional specifications of ICS2 the pre-loading (F32) and the pre-arrival ENS filings (F30, F31, F33) part of the same ENS are expected to be lodged by the same declarant (different representatives can be used for the message exchanges). Otherwise, they cannot be linked and the PLACI will be considered as missing.

Regarding the lodgement of the corresponding Arrival notification to ICS2 or the Presentation notification to the national presentation systems, there is no constraint/requirement for correspondence of the declarant to, respectively, the person notifying the arrival/notify party or the person presenting the goods.

4.1.3 Supplementary declarant

In the context of a complete ENS composed of partial ENS filings this is a party which is indicated in another ENS filing as expected to lodge an additional ENS filing either at house or sub-house level.

4.1.4 Representative

As per Art. 18, UCC any person can appoint a representative to create and lodge the ENS or a particular ENS filing in the name and on behalf of the declarant (direct representation) or in the representative's name but on behalf of the declarant (indirect representation). In case of direct representation, the declarant is held legally responsible as if he had lodged the ENS himself as above. The direct representative is liable with regard to his declarant but not regarding the customs authorities.

As a rule, a representative may be any person referred to in Art. 5 (4) UCC. The representative may be in particular customs broker, freight forwarder, carrier etc.

In other terms, when the customs broker of an operator operates under direct customs representation, the liability is wholly and only on the shoulders of the operator while in the case of indirect representation the liability is shared.

Hence, the Customs indirect representative can be assimilated to the "declarant"; the declaration is in the Customs indirect representative's name. This means that the Customs indirect representative (like the declarant) is responsible for the contents of the declaration and is also liable for compliance with the obligations related to filing the declaration. This is not the case for the Customs direct representative where the liability lies with the person represented.

Customs may ask evidence of the empowerment which usually takes the form of a written authorization.

However the customs authorities shall not require a person acting as a customs representative, carrying out acts and formalities on a regular basis, to produce on every occasion evidence of empowerment, provided that such person is in a position to produce such evidence on request by the customs authorities.

Persons who fail to state that they are acting as a customs representative or who state that they are acting as a customs representative without being empowered to do so shall be deemed to be acting in their own name and on their own behalf. In other words if the representative does not state the level of representation on the customs declaration, he/she will be deemed to be acting as an indirect representative, that is, acting in their own name, but on behalf of another person, and would then be jointly liable with the importer/exporter/principal for any customs debt. They may also be liable to a penalty.

4.1.5 Person filing

The person who has created and lodged an ENS filing. It either is the declarant or in case of representation – the representative.

4.1.6 Carrier

The carrier in the context of entry is the person who brings the goods/items/consignments, or who assumes responsibility for the carriage of the goods/items/consignments, into the customs territory of an ICS2 country. In the case of combined transportation, a carrier means the person who operates the means of transport, which once brought into the customs territory of the ICS2 countries, moves by itself as an active means of transport. In the scope of the current document the carrier is the air cargo general carrier transporting express consignments or the express carrier operating their own aircrafts.

4.1.7 House filer

A house filer is an entity carrying out operations related to consignments or person having at its disposal all the necessary data elements to lodge ENS filing containing house level information, e.g., freight forwarder, ground handling agent, importer.

The express operators lodging F33 are house filers from the perspective of the air cargo general carriers who are expected to lodge F21 in the case of 5.2.3.2.2 F32 lodged pre-loading and F33 & F21 lodged pre-arrival.

4.1.8 Person notifying the arrival

A Person notifying the arrival is normally the operator of the active means of transport entering the ICS2 countries customs territory and submitting the Arrival notification.

4.1.9 Notify party

A Notify party is an entity which has an agreement with the person notifying the arrival. In case of the express consignment on air cargo general, the express operator can be indicated by the carrier as a Notify party in the Arrival notification to take part in the arrival process.

4.1.10 IT service provider

The IT service provider is the person operating an access point to ICS2 who technically submits and receives electronic messages for declarants and representatives. It is considered to be a sender of the messages but not the declarant. Nevertheless, an IT service provider can be a representative in parallel when customs representation services are provided as well. A declarant who is operating its own access point to ICS2 for own submissions without providing services to other declarants/representatives is not considered to be an IT service provider.

4.1.11 Consignor

The party consigning goods as stipulated in the transport contract by the party ordering the transport.

In the context of F31 – party (usually the express operator) consigning goods as stipulated in the transport contract by the party ordering the transport must be provided at the master consignment level. Party consigning the goods as stipulated in the lowest House Bill of Lading or in the lowest House Air waybill must be provided at house consignment level. This person must be different from the carrier, freight forwarder, consolidator, postal operator, or customs agent.

In the context of F30, F32, F33 – party consigning goods as stipulated in the transport contract by the party ordering the transport must be provided at the master consignment level. Party consigning the goods as stipulated in the lowest House Bill of Lading or in the lowest House Air waybill must be provided at house consignment level. This person must be different from the carrier, freight forwarder, consolidator, postal operator, or customs agent.

4.1.12 Consignee

The party to whom goods are actually consigned.

In the context of F31 – party (usually the express operator) to whom the goods are actually consigned must be provided at the master consignment level. Party receiving the goods as stipulated in the lowest House Bill of Lading or in the lowest House Air waybill must be provided at house consignment level. This person must be different from the freight forwarder, (de)consolidator, postal operator, or customs agent.

In the context of F30, F32, F33 – party receiving the goods as stipulated in the lowest House Bill of Lading or in the lowest House Air waybill must be provided at house consignment level. This person must be different from the freight forwarder, (de)consolidator, postal operator, or customs agent.

4.2 ICS2 Country roles

4.2.1 Addressed Member State (AMS)

The 'Addressed Member State' for the pre-loading ENS filings is the country of the Customs Office of first entry to the best of the knowledge of the person filing at the time of lodgement of the ENS filing.

4.2.2 Responsible Member State (RMS)

The Responsible Member State is an ICS2 country that has the legal responsibility to ensure that the risk analysis is carried out and finalized primarily for security and safety purposes i.e. responsible to make a decision in terms of the necessary measures to be taken to mitigate an identified risk.

4.2.3 Involved Member State (IMS)

An IMS is considered to be an ICS2 country that is referenced in the ENS data and that is contributing to the risk assessment.

4.2.4 Member State of Control

The Member State of control has the final decision on whether to actually control the goods or not, taking into account the results of risk analysis and any control recommendations of the RMS and performing the controls.

4.3 Customs offices roles

4.3.1 Customs office of first entry (COFE)

This is the customs office competent for the place where border transport means carrying the goods arrive first in the territory of an ICS2 country.

The actual customs office of first entry refers to the actual place (and competent customs office) where the means of transport carrying the goods enters for the first time the territory of the ICS2 country coming from a 3rd country.

4.3.2 Customs office of unloading

This is the customs office competent for the place of unloading, e.g. seaport, airport, freight terminal, rail station or any place where the goods are unloaded from the means of transport having been used for their carriage.

4.3.3 Customs office of presentation

The customs office competent for the approved place of presentation of the goods to customs.

5 ICS2 PROCESS DESCRIPTION

5.1 General ICS2 process overview

The ICS2 system implements the handling of the advance cargo information requirements under the Union Customs Code. There are two phases of lodgement of information to ICS2 for the express consignments entering the ICS2 countries – pre-loading and pre-arrival:

- The air pre-loading risk assessment focuses only on the aviation security risks (a.k.a. the bomb-in-the-box);
- The pre-arrival risk assessment, unlike the air pre-loading risk analysis, which strictly covers aviation security risks, assesses safety and security threats, which reflect a wider range of risks. The safety and security risks are threats that can have serious implications for the security, health and wellbeing of people and/or the environment. They can be linked to both, misdeclarations or illicit activities (for example, negligence, criminal organisations, terrorism, etc.).

The ICS2 system supports the following processes:

- Lodgement and validation of ENS filings;
- Issuing of Assessment complete/DNL notifications;
- Handling of referrals (Request for Information (RfI), Request for Screening (RfS)) (out of scope for this guidance document);
- Amendment of ENS filings;
- Invalidation of ENS filings;
- Lodgement of an arrival notification for the means of transport entering the territory of the ICS2 countries for the first time;
- Presentation of goods to customs (via a national presentation system for the economic operators);
- Control notifications (including advanced control notification for authorized economic operators) by customs, if/where required.

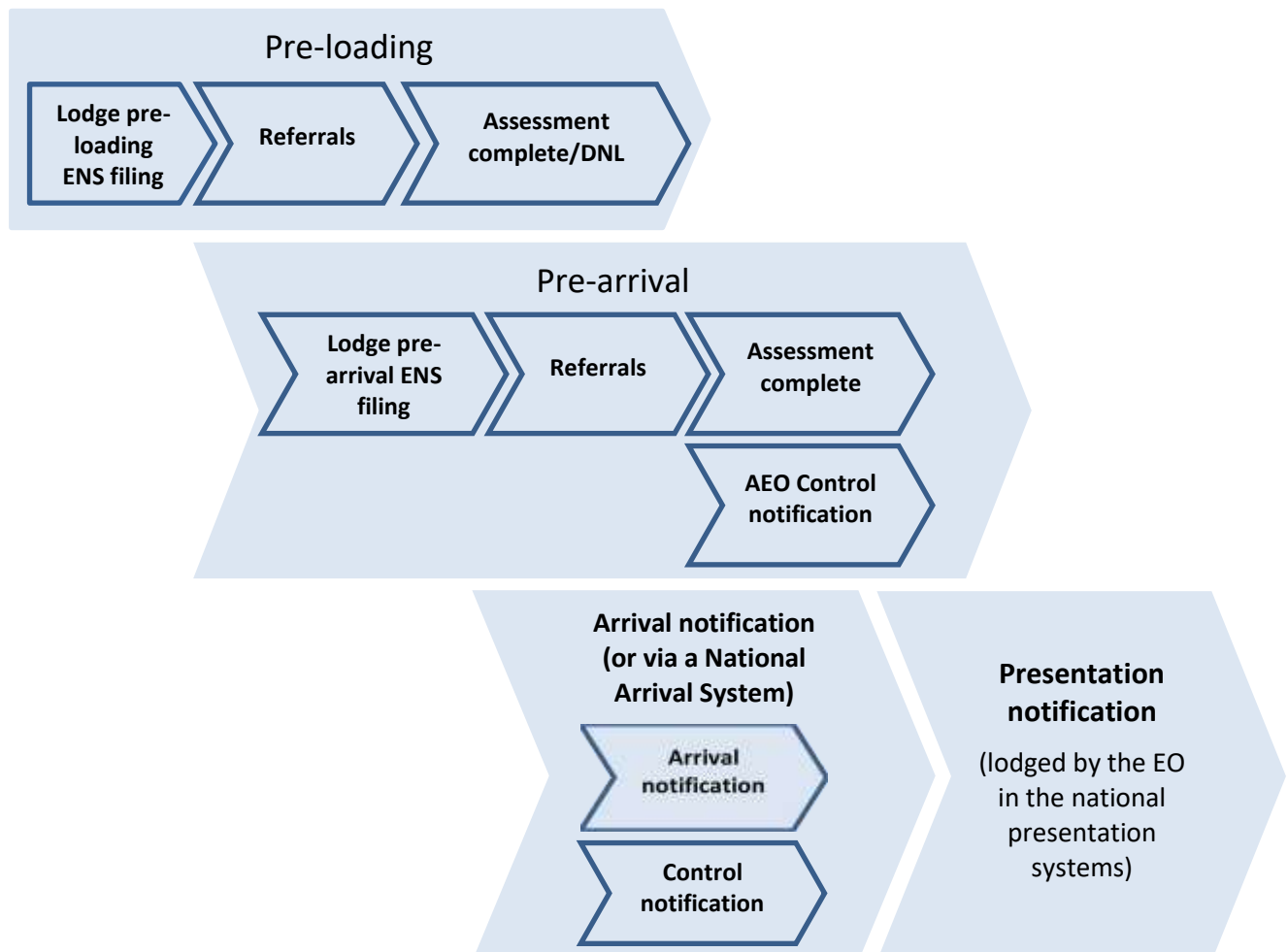

Figure 1: ICS2 Process phases

There are four main phases of the ICS2 process from the perspective of the processing of the ENS. First, the pre-loading minimum part of the ENS particulars are lodged and assessed within the established time limits. Once the pre-loading part of the process is completed, the pre-arrival details of the ENS are provided and the complete ENS is initiated, the pre-arrival risk assessment within the defined time limits is triggered. The time limits for the provision of the pre-arrival ENS information depend on the flight duration – short or long haul. The arrival notification for the plane which has arrived to the territory of the ICS2 countries is lodged to the actual COFE which could be different from the declared COFE in the ENS due to a diversion. Usually the arrival notification is lodged after the plane has landed. There are no legally defined timelines for the lodgement of the arrival notification. During the arrival notification some controls can be notified to the Person notifying the arrival and the Notify party(ies) (the Notify party indicated in the Arrival notification, not in the ENS filing). The last stage of the process is the presentation of the ENS/House consignments – the Person presenting the goods needs to lodge a Presentation notification in the national presentation system of the country where the goods are unloaded.

The lodgement of the ENS data during pre-loading is based on the submitted F32 ENS filing. During the pre-arrival stage the ENS information can be provided via one of the ENS filings combinations elaborated in Section 5.2.3 ENS filings combinations.

The persons filing the ENS filings receive the below listed notifications/requests during the different stages of the ICS2 process:

- ENS registration response (with the allocated MRN) (IE3R01);
- ENS lifecycle validation error notification (IE3N01);
- Assessment complete (AC) notification (IE3N03) per house consignment during pre-loading and per ENS during pre-arrival for the EO's who have subscribed to receive this notification;
- DNL request (IE3Q01) (when serious risk was identified);
- Additional information request (IE3Q02) for provision of additional details;
- High Risk Cargo & Mail screening request (IE3Q03) for the cargo to be further screened via recommended screening methods;
- House consignment in incorrect state notification (IE3N07);
- AEO Control notification during the pre-arrival (IE3N09) notifying the express operator with status of an authorized economic operator of the intended by the customs authorities controls;
- Control notification (IE3N08) after arrival of the goods is notified for the high risk goods to be controlled (does not replace the control notifications during the presentation of the goods);
- Amendment notification (IE3N10);
- ENS pending notification (IE3N11);
- Error notification (IE3N99).

5.2 ICS2 R2 processes for express consignments

5.2.1 ENS filings lodged pre-loading

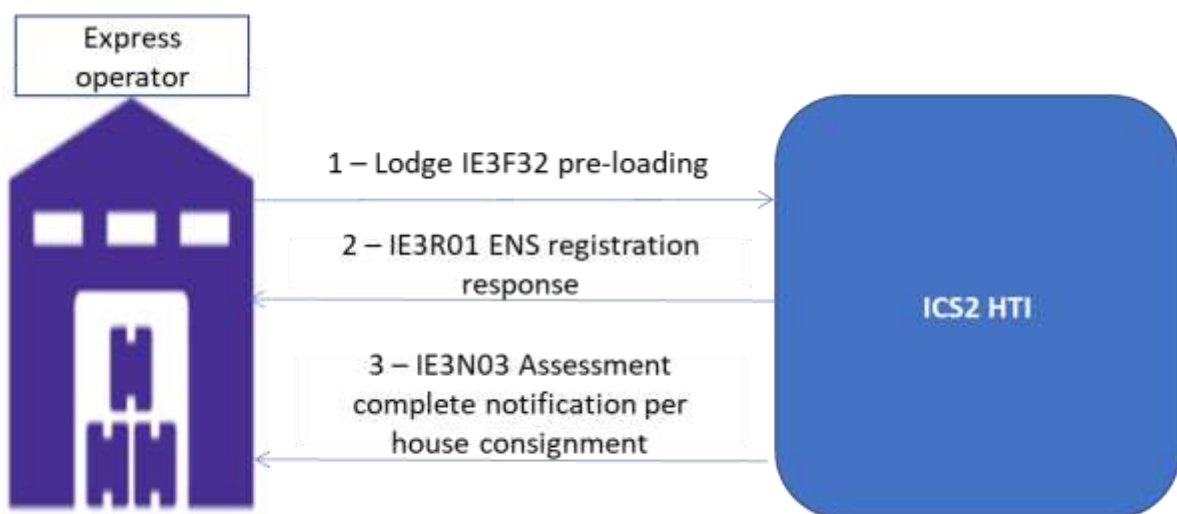

Figure 2: F32 lodged in ICS2 HTI

In ICS2 R2 the express carriers provide the minimum dataset using IE3F32 ENS filing prior to the loading of the goods onto the aircraft with destination in the ICS2 countries. F32 is lodged as soon as the information is available to the express operator. The Addressed Member State is the country where the goods are expected to enter the territory of the ICS2 country for the first time to the best of the knowledge of the express carrier upon the lodgement of the ENS filing.

ICS2 performs syntactical, semantic and lifecycle validation on the received F32. In case the provided ENS filing is valid, it is registered, accepted and an MRN is assigned. The acceptance of the ENS filing is communicated via the ENS acceptance response (IE3R01).

The LRN indicated in the F32 should be unique for the particular economic operator.

Each house consignment must be uniquely identified and this identifier cannot be reused for 12 month. For the express consignments the unique identifier is the combination of the “Transport document (House level)/Reference number” and the “UCR/Reference number”.

In case the ENS filing is rejected, this will be communicated back to the express operator either via IE3N99 Error notification or via IE3N01 ENS lifecycle validation error notification, depending on the type of the error leading to the rejection. For example, if there is an XSD validation error (mandatory field not provided, format violation, code list values violation, etc.) IE3N99 Error notification will be returned. In case there is a duplicate house consignment provided, for example, IE3N01 will be returned pointing to the house consignment. In this case the updated version of the lodged F32 should be lodged with the necessary corrections.

After the risk assessment of the lodged F32 is completed, an Assessment complete notification is generated per house consignment. In case aviation security threat is detected, the IE3Q01 DNL request message is communicated to the express operator triggering the aviation security protocols [R10].

During pre-loading risk assessment customs authorities can issue IE3Q02 Additional information request/IE3Q03 High Risk Cargo & Mail screening request before the decision on the risk assessment result. The details related to the referrals handling are elaborated in the referrals guidance document [R06] and are out of scope for the current document.

The result of the air pre-loading risk analysis can have two different outcomes:

- The HC is not considered to be a serious threat to aviation security.
- The HC is considered to be a serious threat to aviation security.

In the first case, ICS2 will send an assessment complete notification (IE3N03) per house consignment (in pre-loading) to the person filing where this person has subscribed to receive such notification in its preferences. The received IE3N03 Assessment complete notification means that the goods can be loaded and at the time of receipt of the assessment complete notification no serious threat is identified as per the information available to the customs authorities at that moment.

The principles for the Assessment complete notification are depicted below:

IE3N03	F32
	Per HC
MRN	F32 MRN
CompletionDate	X
Assessment Complete/transport document (house level)	X
ResponsibleMemberState	X
Representative	X
Declarant	X

Figure 3: Assessment complete notifications content for express pre-loading

In the second case when the HC is considered to be a serious threat to aviation security then an IE3Q01 DNL Request is sent to the express operator.

5.2.2 ENS filings lodged pre-arrival (as of R2)

As of ICS2 R2, in addition to the pre-loading data (F32) submitted by the express operators, they are also expected to provide the complete ENS before the arrival of the goods. The pre-arrival ENS information is provided by the submission of F30, F31 or F33 in combination with F21 (submitted by the air carrier).

The choice of the particular pre-arrival ENS filing to be submitted depends on whether the express consignments are transported on flights operated by the express carrier (F30) or aircrafts operated by air cargo general carriers. If the air cargo general operator provides the master related information – conveyance, actual date and time of departure, estimated date and time of arrival, means of transport routing information and COFE – to the express operator, then F31, containing the complete pre-arrival information, can be submitted by the express operator itself. Otherwise, the air cargo general carrier can lodge F21 with the master related information and the express operator can lodge F33 with the rest of the pre-arrival ENS information.

Based on the combination of the pre-loading and the pre-arrival ENS filings, the complete ENS is composed.

Each submitted ENS filing is assigned its own MRN. The MRN of the ENS is the MRN of the ENS filing containing the master related information – F30, F31 or F21.

The assessment complete for pre-arrival is not generated per house consignment as in the pre-loading phase, but per ENS and communicated back to the persons filing the pre-arrival ENS filings.

In case an additional information is needed during the pre-arrival phase, then IE3Q02 Additional information request is received by the declarant. Further details for this part of the process are elaborated in the referrals guidance [R06].

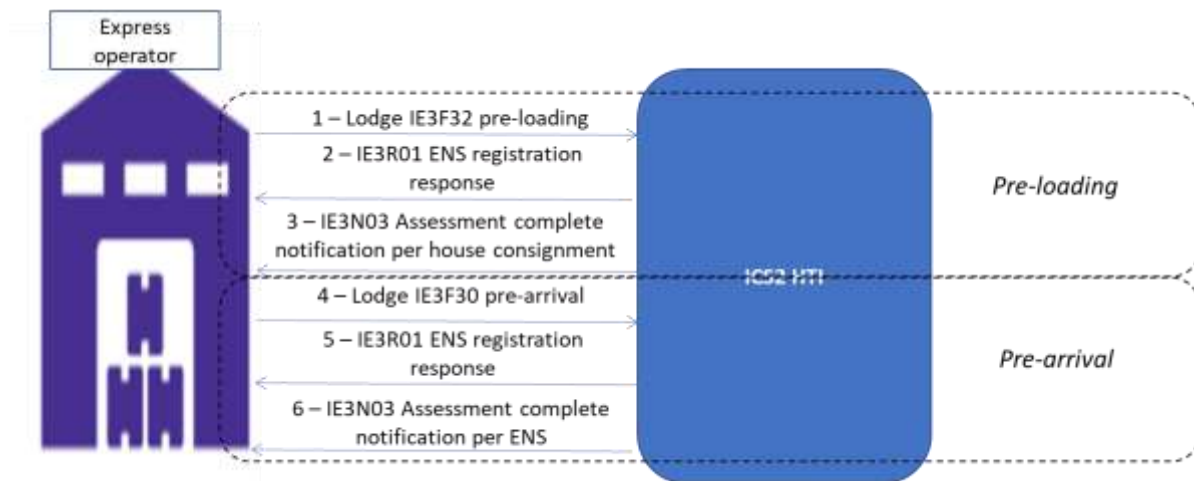

Figure 4: Pre-loading and pre-arrival express ENS filings

Examples of all combinations are elaborated in Section 5.2.3 ENS filings combinations.

After the pre-arrival risk analysis the Assessment complete notification is sent to the economic operator per ENS, not per house consignment.

The principles for the Assessment complete notification are depicted below:

IE3N03	F30	F31	F33
	Per ENS	Per ENS	Per ENS
MRN	F30 MRN	F31 MRN	F33 MRN
CompletionDate	X	X	X
Assessment Complete/transport document (house level)	x*	-	x*
ResponsibleMemberState	X	X	X
Representative	X	X	X
Transport Document Master Level	-	X	X
Carrier	X	X	X

Declarant	X	X	X
-----------	---	---	---

Figure 5: Assessment complete notifications content for express pre-arrival

x* - if everything is ok, no list of house consignments to be returned (only the MRN of the ENS filing and Master transport document, if applicable). If there is a problem with one of the house consignments, a list of the house consignments for which there is no problem to be returned.

5.2.3 ENS filings combinations

5.2.3.1 Express consignments on own aircraft (F32 lodged pre-loading and F30 lodged pre-arrival)

The express operator carries goods on their own aircraft or on chartered aircraft operated as owned by the express operator with no air cargo general carriers involved. There is no master transport document, only master level transport related information – conveyance, routing, time of departure/arrival, COFE.

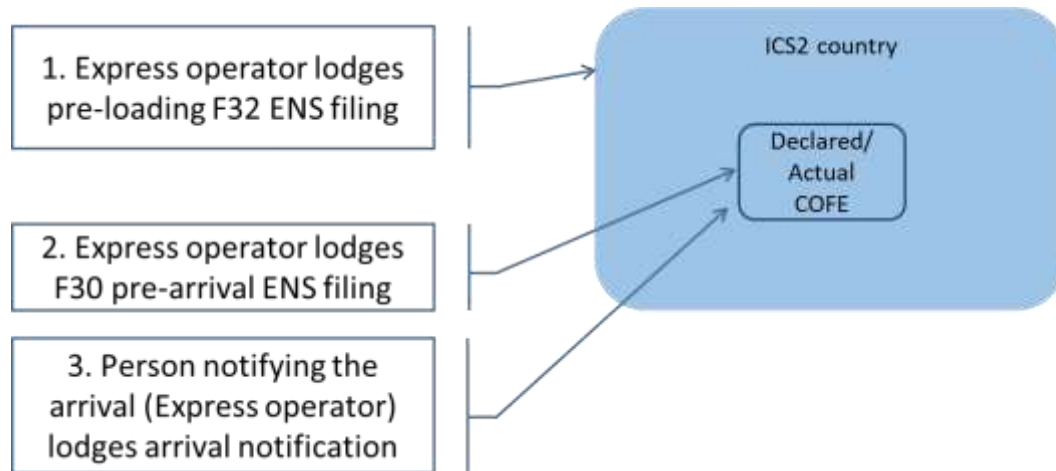

Figure 6: F32 + F30

1. The express operator lodges F32 pre-loading with the minimum dataset to the ICS2 country (AMS) where the goods are expected to enter the territory of the ICS2 country (to the best of their knowledge).
2. The express operator lodges a pre-arrival ENS filing F30 to the ICS2 country of the declared (expected) Customs Office of First Entry.
3. An Arrival notification containing a reference to F30 is lodged in the airport of the actual COFE (not any subsequent airport).
4. A presentation notification is sent to the Customs authorities' national presentation system where the goods are unloaded.

5.2.3.2 Express consignments on air cargo general

5.2.3.2.1 F32 lodged pre-loading and F31 lodged pre-arrival

Express consignments are transported by general air cargo carrier, the ENS in pre-arrival is lodged by the express operator. The air cargo general carrier provides the express operator with the master level information.

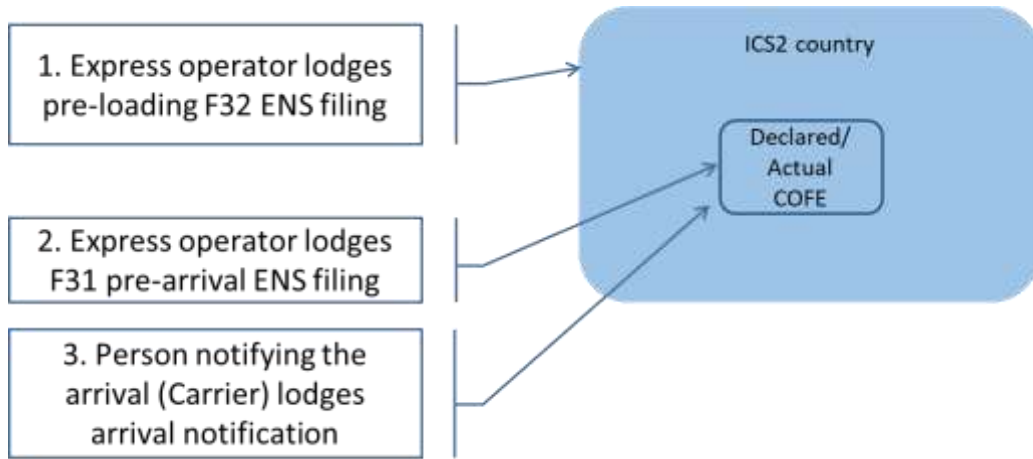

Figure 7: F32 + F31

1. The express operator lodges F32 pre-loading with the minimum dataset to the ICS2 country (AMS) where the goods are expected to enter the territory of the ICS2 country (to the best of their knowledge).
2. The express operator lodges a pre-arrival ENS filing F31 to the ICS2 country of the declared (expected) Customs Office of First Entry.
3. An Arrival notification containing a reference to F31 is lodged in the airport of the actual COFE (not any subsequent airport).
4. A presentation notification is sent to the Customs authorities' national presentation system where the goods are unloaded.

5.2.3.2.2 F32 lodged pre-loading and F33 & F21 lodged pre-arrival

The express consignments are transported by air cargo general carrier. The master transport related information is provided by the carrier via F21 – conveyance, routing, time of departure/arrival, COFE, etc.

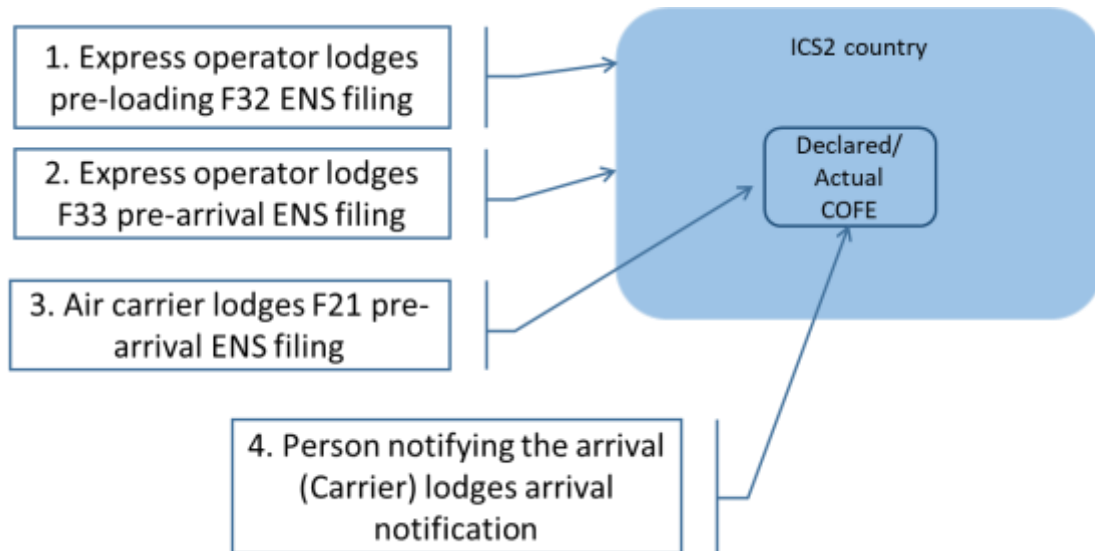

Figure 8: F32 + F33 + F21

1. The express operator lodges F32 pre-loading with the minimum dataset to the ICS2 country (AMS) where the goods are expected to enter the territory of the ICS2 country (to the best of their knowledge).
2. The express operator lodges a pre-arrival ENS filing F33 to the ICS2 (AMS) country where the goods are expected to enter territory of the ICS2 country (to the best of their knowledge).
3. The air carrier lodges a pre-arrival ENS filing F21 to the ICS2 country of the declared (expected) Customs Office of First Entry.
4. An Arrival notification containing a reference to F21 is lodged in the airport of the actual COFE (not any subsequent airport).

5. A presentation notification is sent to the Customs authorities' national presentation system where the goods are unloaded.

In case the Express operator does not lodge F33 but an F21 is lodged for the same master transport document and the Express operator is indicated as a supplementary declarant in F21 then the Express operator will receive IE3N11 ENS pending notification indicating the master transport document reference for which the F33 has not been lodged.

5.2.4 Split consignment

The "Split consignment indicator" is available in the ENS filings containing the master level information such as F30, F31 and F21. It is envisaged for the cases, when the split consignment is not planned. During the loading of the goods it can be established, that not all goods covered by an ENS can be loaded on the indicated flight. For this purpose, the same content of the initially lodged ENS is submitted with "Split consignment indicator" "True", the same house consignments content and the updated master related information such as the conveyance, date and time of arrival/departure, routing, COFE. Consequently, it is possible to indicate different COFE's, conveyance, times, routing countries. The availability of the "Split consignment indicator" is to facilitate the person filing not to distinguish which house consignments and goods items are actually loaded, since it can be difficult to establish precisely this information and to prevent the necessity to issue a new master transport document. The first lodged master ENS filing should be with "Split consignment indicator" filled in as "False", only the subsequent ones, since when the initial master ENS filing is lodged it most probably is not known that there will be a split of the house consignments. The "Split consignment indicator" equal to "True" prevents the subsequent master ENS filing to be rejected due to non-unique Master transport document reference.

In case it is known in advance that the house consignments are expected to enter the ICS2 countries via different COFE's, then for each group of house consignments a separate master level ENS filing must be lodged with the correct transport related information – COFE, routing, conveyance, departure/arrival times.

The split consignment functionality is envisaged only for the master level ENS filings since the house filers are not expected to know the changes in the master related information. In case F21 and F33 filings are used to lodge an ENS, F21 needs to be re-lodged with the "Split consignment indicator" set to "True", and F33 filing, lodged for the first ENS, is linked to the new F21 ENS filing. In case of split consignment, F32 is not expected to be lodged again.

In the F30 ENS filing in addition to the "Split consignment indicator" there is "Previous MRN" to be provided. It must contain the MRN of the initially submitted F30 since there is no "Master transport document" and there is no other way to relate the two ENS filings but the MRN of the initially submitted one.

The house consignments which have actually arrived are known only after the presentation of the house consignments.

5.2.4.1 Split consignment for express – COFE in different ICS2 countries

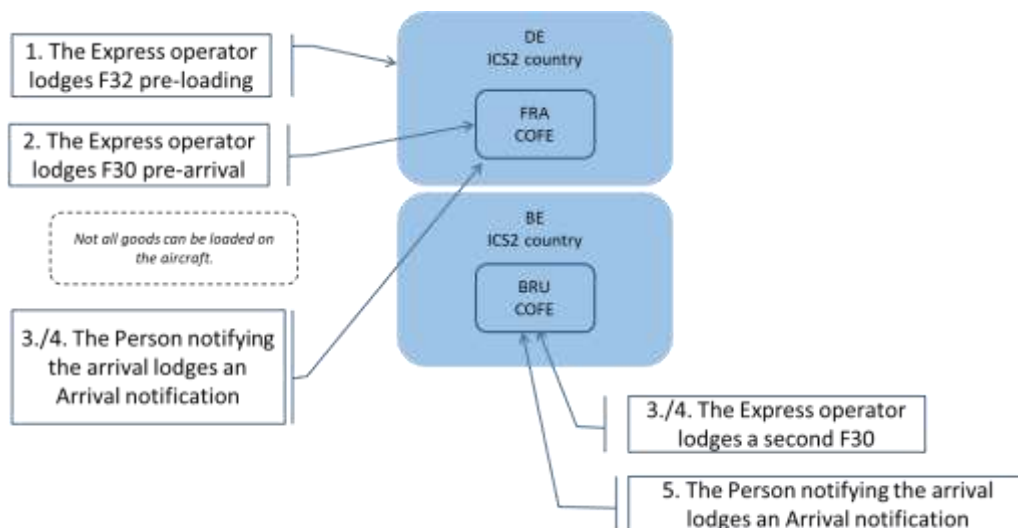

Figure 9: Split consignment for express - COFE in different ICS2 countries

1. The express operator lodges F32 pre-loading with the minimum dataset to the ICS2 country (AMS) where the goods are expected to enter the territory of the ICS2 country (to the best of their knowledge).

2. The express operator lodges a pre-arrival ENS filing F30 to the ICS2 country of the declared (expected) Customs Office of First Entry.

(then it turns out that not all goods can be loaded on the aircraft so they need to be loaded on a subsequent flight and another F30 is needed)

3./4. An Arrival notification containing a reference to F30 is lodged in the airport of the actual COFE..

3./4. The Express operator lodges a second F30 with identical content as the first one (not changed based on the loaded goods), Split consignment indicator “True” and updated movement related information (conveyance, times, routing, COFE).

5. An Arrival notification is lodged containing a reference to the second F30 by the express operator to the airport of the actual COFE where the goods from the second ENS arrive.

6. A presentation notification is sent to the Customs authorities’ national presentation system where the goods are unloaded.

5.2.4.2 Split consignment for express – same COFE

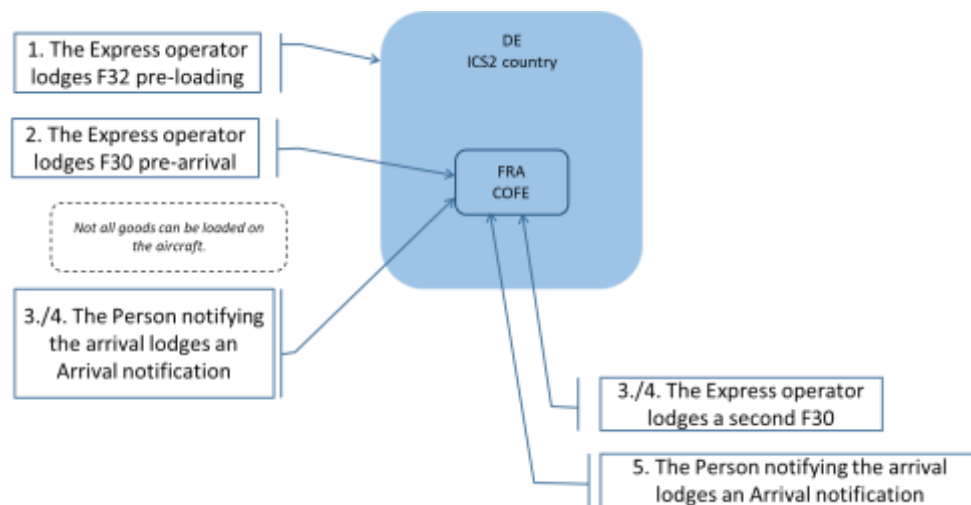

Figure 10: Split consignment for express - same COFE

1. The express operator lodges F32 pre-loading with the minimum dataset to the ICS2 country (AMS) where the goods are expected to enter the territory of the ICS2 country (to the best of their knowledge)..

2. The express operator lodges a pre-arrival ENS filing F30 to the ICS2 country of the declared (expected) Customs Office of First Entry.

(then it turns out that not all goods can be loaded on the aircraft so they need to be loaded on a subsequent flight and another F30 is needed)

3./4. An Arrival notification containing a reference to F30 is lodged in the airport of the actual COFE.

3./4. The Express operator lodges a second F30 with identical content as the first one (not changed based on the loaded goods), Split consignment indicator “True” and updated movement related information (conveyance, times, routing, COFE).

5. An Arrival notification containing a reference to the second F30 is lodged by the express operator to the airport of the actual COFE where the goods from the second ENS arrive.

6. A presentation notification is sent to the Customs authorities’ national presentation system where the goods are unloaded. The presentation could be partial as soon as the goods are unloaded or complete containing the full set of goods once all of them arrive and are unloaded.

5.2.4.3 Split consignment for express on air cargo general – COFE in different ICS2 countries

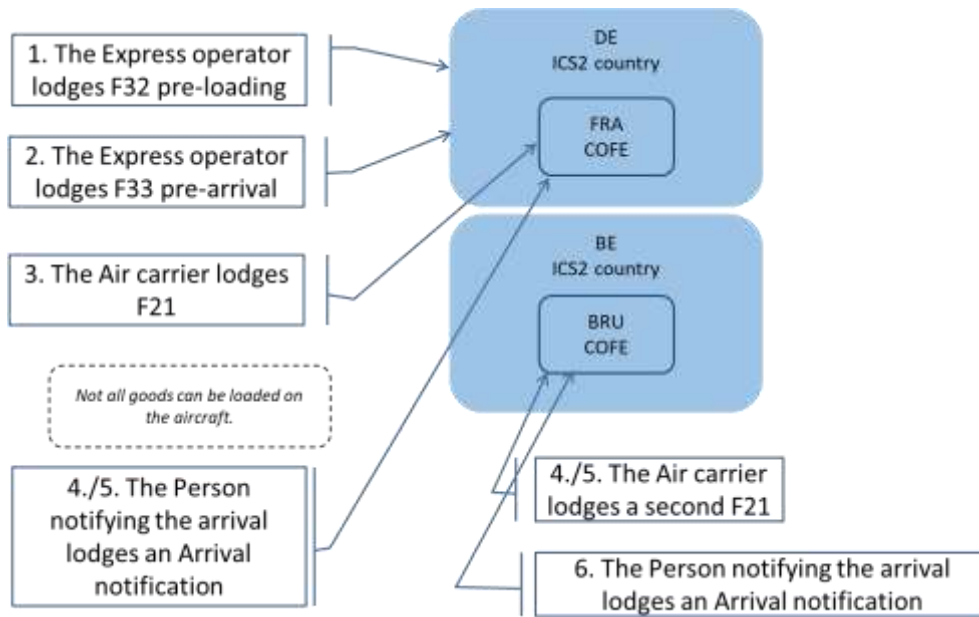

Figure 11: Split consignment for express on air cargo general - COFE in different ICS2 countries

1. The express operator lodges F32 pre-loading with the minimum dataset to the ICS2 country (AMS) where the goods are expected to enter the territory of the ICS2 country (to the best of their knowledge)..

2. The express operator lodges a pre-arrival ENS filing F33 to the ICS2 (AMS) country where the goods are expected to enter the territory of the ICS2 country (to the best of their knowledge).

3. The air carrier lodges a pre-arrival ENS filing F21 to the ICS2 country of the declared (expected) Customs Office of First Entry..

(then it turns out that not all goods can be loaded on the aircraft so they need to be loaded on a subsequent flight and another F21 is needed)

4./5. An Arrival notification containing a reference to F21 is lodged in the airport of the actual COFE.

4./5. The air carrier lodges a second F21 with identical content as regards the goods as the first one (not changed based on the loaded goods) and Split consignment indicator "True", updated movement related information (routing, date and times, conveyance, COFE) and the same "Master transport document reference" to the second COFE.

6. An Arrival notification containing a reference to the second F21 is lodged in the airport of the second actual COFE.

7. A presentation notification is sent to the Customs authorities' national presentation system where the goods are unloaded..

5.2.4.4 Split consignment for express on air cargo general – same COFE

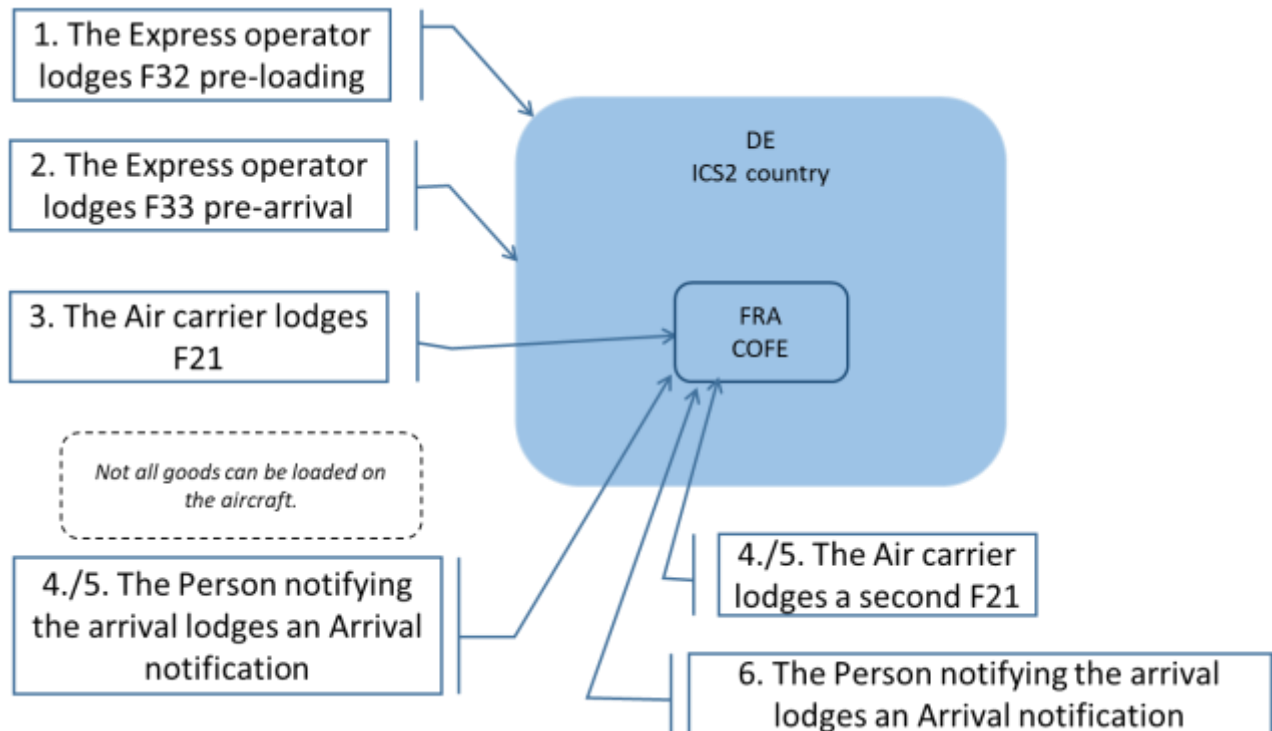

Figure 12: Split consignment for express on air cargo general – same COFE

1. The express operator lodges F32 pre-loading with the minimum dataset to the ICS2 country (AMS) where the goods are expected to enter the territory of the ICS2 country (to the best of their knowledge).
2. The express operator lodges a pre-arrival ENS filing F33 to the ICS2 (AMS) country where the goods are expected to enter the territory of the ICS2 country (to the best of their knowledge).
3. The air carrier lodges a pre-arrival ENS filing F21 to the ICS2 country of the declared (expected) Customs Office of First Entry..

(then it turns out that not all goods can be loaded on the aircraft so they need to be loaded on a subsequent flight and another F21 is needed)

4./5. An Arrival notification containing a reference to F21 is lodged in the airport of the actual COFE

4./5. The Air carrier lodges a second F21 with identical content related to the goods as the first one (not changed based on the loaded goods) and Split consignment indicator “True”, updated movement related information (routing, date and times, conveyance) and the same “Master transport document reference”.

6. An Arrival notification containing a reference to the second F21 is lodged in the airport of the second actual COFE.

7. A presentation notification is sent to the Customs authorities’ national presentation system where the goods are unloaded. The presentation could be partial as soon as the goods are unloaded or complete containing the full set of goods once all of them arrive and are unloaded..

5.2.5 Re-entry

The ENS filings containing the master level information such as F30, F31, F21 have an additional “True”/“False” data element “Re-entry indicator”. The purpose of this element is to indicate if the lodged ENS filing contains a master transport document, which has already been used for an ENS which covered the consignment, that entered the customs territory of the ICS2 country, but on the route has exited the territory and re-enters the same or other ICS2 country. The reason behind this field is to avoid the uniqueness check violation of the master transport document. In case of the ENS filed via multiple partial ENS filings, only the master level ENS filing needs to be re-lodged for the re-entry. The house level ENS filings, which were filed for the first ENS, will be linked to the new ENS.

The re-entry can be a planned route or due to a diversion/change in the route which are not as per the plan.

The lodged master ENS again triggers the pre-arrival risk analysis and an assessment complete for the ENS is generated. No F32 is expected to be lodged again.

<i>Example</i>	<p>The express operator lodges F32 pre-loading for goods arriving from UAE to Germany via Greece and Serbia. Since the goods are expected to enter the ICS2 country for the first time in Greece, then F32 is addressed to Greece. Then they lodge an F30 in pre-arrival. The F30 is lodged with COFE Greece with all countries of routing indicated. An Arrival notification is lodged for the ENS for the means of transport arriving to Greece. Once arrived, the goods are not unloaded and the flight continues to Serbia. Then the aircraft heads towards Germany. Since Serbia is a 3rd country, the goods arriving from there to Germany are treated as entering the customs territory of the ICS2 country for the first time. Another F30 with updated movement related information, e.g. flight, dates, etc. and the re-entry indicator filled in as “True” is lodged to Germany. Then another Arrival notification is lodged for this ENS with COFE in Germany.</p>
----------------	---

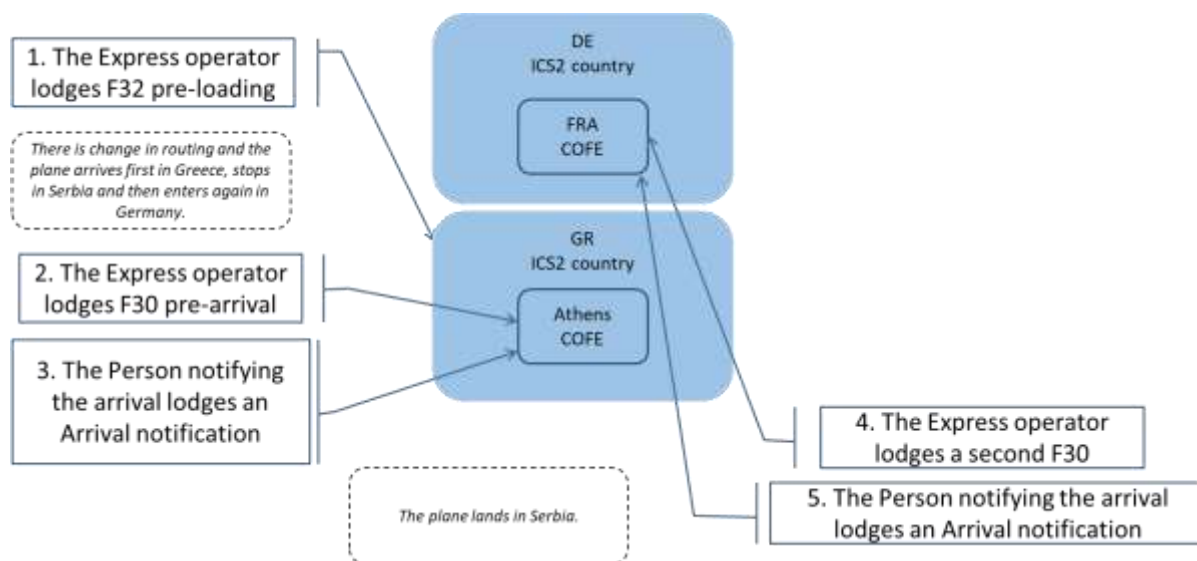

Figure 13: Re-entry for express consignments

1. The express operator lodges F32 pre-loading with the minimum dataset to the ICS2 country (AMS) where the goods are expected to enter the territory of the ICS2 country (to the best of their knowledge) – in this case is Greece.

As per the routing the plane arrives first in Greece, stops in Serbia and then enters again in Germany. (The scenario is the same if the stop in Serbia is either planned or not planned (diversion)).

2. The Express operator lodges F30 ENS filing pre-arrival with the full information for the house consignments and the master related information to the ICS2 country where the goods are expected to enter the ICS2 countries territory, COFE – Greece.

3. The Person notifying the arrival (Express operator) lodges an Arrival notification containing a reference to the F30 ENS to the COFE.

After that the plane lands in Serbia.

4. The Express operator lodges a second F30 with updated content (updated flight information e.g. conveyance, times, routing) and Re-entry indicator “True”.

5. The Person notifying the arrival (Express operator) lodges an Arrival notification containing a reference to the second F30 ENS to the COFE in Germany.

6. A presentation notification is sent to the Customs authorities’ national presentation system where the goods are unloaded.

5.2.6 Referrals

The details regarding the referrals are part of the EU guidance on air cargo security referral protocols for ICS2 [R06] and will not be duplicated as part of the current guidance document.

5.2.7 Arrival notification (as of R2)

For each arriving aircraft (depending on the airport operational arrangements) to a COFE an Arrival notification (IE3N06), listing the references to the ENSs for the goods transported on-board, is lodged. The person notifying the arrival (the operator of the means of transport) can decide where to lodge the Arrival notification – either via the ICS2 HTI or the National Arrival System, if any in the ICS2 country of the COFE. One Arrival notification (IE3N06) is expected per arriving means of transport.

There are three options for referring to the ENSs in the Arrival notification. They are mutually exclusive and are based on the content of the provided Arrival notification in the below priority:

1. The MRN of the ENS (the MRN of the ENS filing containing the master level transport information).
2. The “Master transport document reference number” and the “Estimated date and time for arrival”.
3. The “Active border transport means”/“Conveyance reference number” and the “Estimated date and time of arrival”.

In case a list of ENS MRNs is provided, then the other two combinations are not searched. If no MRN is provided, then the ENSs are searched based on the combination of a “Master transport document reference number” and the “Estimated date and time for arrival”. If no “Master transport document reference number” is provided, then it is checked if any ENS can be identified based on the “Conveyance reference number” of the “Active border transport means” and the “Estimated date and time of arrival”.

The Arrival notification contains the Person notifying the arrival and, if any, a list of Notify parties. If the Person notifying the arrival is not the express operator, then the express operator can be indicated as a Notify party. The Notify party receives an IE3R04 Arrival registration response with the assigned to the registered Arrival notification MRN. In case of an issued control notification by the COFE, the Notify party receives IE3N08 Control notification.

In case the Arrival notification contains references to ENSs which are already presented or controlled, the following notification is communicated to the Person notifying the arrival – IE3N07 House consignment in incorrect state notification listing the ENSs and the relevant house consignments in incorrect state. In case the house consignments were part of re-entry/split consignment then no IE3N07 House consignment in incorrect state notification is communicated back to the EO. If such a notification is received, it is expected from the Person notifying the arrival to further investigate what is the reason for goods already presented/controlled to be indicated for arrival. This could be an indication of some misalignments in the steps of the supply chain or incorrect indication of ENS's in the Arrival notification.

In case there is a decision from the COFE to control the goods, an IE3N08 Control notification is sent to the relevant parties – Person notifying the arrival and/or Notify party(s) (the Notify party(s) from the Arrival notification, not from the ENS filing). The controls after arrival are notified for goods which are considered high risk goods which are not aimed to be unloaded at the COFE. When the goods are considered as highly risky they can be notified to be unloaded and presented for controls to the customs authorities.

The control notifications for the regular cases (not high risk cargo) are handled outside ICS2 via the national presentation systems after presentation.

The AEO Control notification can be issued with place of examination not the COFE but the Customs office of destination.

In case of a diversion of the means of transport from one COFE to another COFE within the territory of the ICS2 countries:

1. If no Arrival notification has been lodged, then just an Arrival notification is sent with the correct actual COFE (no amendment of the master level ENS filing is needed).
2. If an Arrival notification has already been lodged, then another Arrival notification is sent with the new actual COFE.

5.2.8 Presentation of goods to customs

The goods entering the territory of the ICS2 countries must be presented at the customs office where they are unloaded from the aircraft. The presentation notification needs to refer to the previously lodged ENS. In case the express operator transports their consignments on their own aircrafts, then the obligation for the presentation of the goods lies with them. In case the express consignments are transported by air cargo general carriers, the presentation depends on the agreement between the two parties.

The presentation notification is to be lodged by the express operator or the air cargo general carrier outside of the ICS2 system (not via the ICS2 STI) directly to the national presentation system at the MS of presentation.

For the access and requirements please consult the published information of the respective national customs administration. The different options for the presentation of the ENS such as the master transport document reference, house consignments, receptacles need to be consulted with the MS of presentation.

5.2.9 Controls of goods by customs

During the pre-arrival risk analysis the customs authorities of the MS of control can decide to notify in advance the economic operator for their decision to perform controls. If the Person filing the ENS is a holder of an AEOS status then an IE3N09 AEO control notification is received. The message contains the Customs office of control, the examination place and the control subject – what entity (house consignment, receptacle, packaging, etc.) needs to be controlled. The IE3N09 AEO control notification is issued after the pre-arrival risk analysis is completed and the assessment complete notification is communicated.

An IE3N08 Control notification is communicated to the Person notifying the arrival and the Notify party (if indicated by the Person notifying the arrival) after the Arrival notification is received.

The goods considered as high risk cargo can be controlled at the COFE, even if they are not envisaged to be unloaded at this customs office. If the identified risks resulting in the decision for control are not high, then the goods will be controlled upon the presentation – either at the Customs office of unloading or the Customs office of destination.

The controls notified after the presentation of the goods are communicated via the national presentation/control systems and not via ICS2.

The responsibility for the presentation of the goods for controls lies with the party handling the unloading of the cargo – it could be the air cargo general carrier, the express operator or the notify party as per the preliminary established agreement between the involved parties in the process for the particular airport, ICS2 country, conveyance or goods.

5.2.10 Subsequent customs procedure

The goods can be released for a subsequent customs procedure only if all entry formalities have been completed – there is a lodged ENS in the first place, any open referrals are closed, the goods are presented and the needed controls, if any, are performed.

5.2.11 Amendments of an ENS filing

In general, there are two reasons for an amendment of the original ENS filing:

- An issued request for additional information (Rfi) of type ‘AMD’ requesting the amendment of an ENS filing particulars or
- Due to a need for amendment identified by the person filing itself. This case applies when the data for a given consignment was incorrect or changed after the submission of the original ENS filing.

When the amendment was requested by the customs authorities via an Rfi, the “Referral request reference” has to be inserted in the respective amendment message (IE3Axx). Else, the amendment will not be recognized by ICS2 as an answer to the Rfi request.

An ENS filing IE3Fxx is to be amended by its respective amendment filing IE3xx. The once amended original filings can be further amended. Sample messages of the amendment filings can be found in the referral guidance document [R06].

Amendments of ENS filings are possible until either:

- The goods covered by the ENS filing to be amended are presented to customs, or
- The customs office notifies controls for the goods covered by the ENS filing to be amended.

The amendment restrictions above apply to all house consignments/goods items contained in the original ENS filing. This means, if only one house consignment of the original ENS filing is presented, no house consignment/goods item contained in that ENS filing can be amended anymore. The same applies for any notified controls.

The data elements in the express ENS filings, which cannot be amended are depicted below per ENS filing type:

The data elements which are not allowed to be amended, per ENS filing type.

Data element	ENS filing type			
	F30	F31	F32	F33
<i>../Specific circumstance indicator</i>	X	X	X	X
<i>../Addressed Member State</i>			X	X
<i>../Representative</i>	X	X	X	X
<i>../Representative / Identification number</i>	X	X	X	X
<i>../Active border transport means / Identity</i>		X		
<i>../Active border transport means / Mode of transport</i>	X	X		X
<i>../Active border transport means / Conveyance reference number</i>	X	X		
<i>../Consignment (Master level) / Carrier / Identification number</i>	X	X		
<i>../Consignment (Master level) / Consignment (House level) / Carrier / Identification number</i>				X
<i>../Consignment (Master level) / Goods item / Goods item number</i>		X		
<i>../Consignment (Master level) / Consignment (House level) / Goods item / Goods item number</i>	X	X	X	X
<i>../Consignment (Master level) / Transport document (Master level) / Document number</i>		X		
<i>../Consignment (Master level) / Consignment (House level) Transport document (Master level) / Document number</i>				X
<i>../Consignment (Master level) / Consignment (House level) / Transport document (House level) / Document number</i>	X	X	X	X
<i>../Declarant / Identification number</i>	X	X	X	X
<i>../Customs office of first entry / Reference number</i>	X	X		

Table 4: Express ENS filings non-amendable data elements

No new house consignments can be introduced and no new goods items of an existing house consignment can be inserted in an amended ENS filing. Any new house consignments must be declared by a new ENS filing. Where a need exists to declare additional goods items for an existing house consignment, the originally submitted ENS filing needs to be invalidated by submitting an invalidation request (IE3Q04). After the invalidation acceptance response (IE3R07) is received, a new corrected ENS filing can be submitted.

Where only particular but not all HC's of an ENS filing are shipped an amendment of the respective original ENS filing can be submitted, which does not contain the short shipped HC's anymore. The ICS2 CR will invalidate the HC's that are no longer present in the amended ENS filing.

5.2.12 Invalidation of an ENS filing

There are two ways for invalidation of an ENS filing:

- The express operator sends an invalidation request (IE3Q04) to ICS2. If the invalidation request is accepted, all house consignments of the respective ENS filing referred to in the invalidation request will be invalidated.
- All house consignments are automatically invalidated after 200 calendar days from the registration date of the ENS filing if they are not presented to customs within this period.

Invalidation of ENS filings is possible until either:

- the goods covered by the relevant ENS filing have been presented to customs, or
- the customs notify controls for the goods covered by the ENS filing to be invalidated.

The invalidation restrictions above apply to all house consignments contained in the original ENS filing. This means, if only one house consignment of the original ENS filing is presented, no house consignment contained

in that ENS filing can be invalidated anymore. The same applies if any house consignment of the ENS filing is notified for controls – the ENS filing cannot be invalidated.

5.2.13 Consult ENS (as of R2)

Each EO can make a request (via IE3Q05) to retrieve information such as the notifications and the entity states related to a particular ENS, ENS filing or transport document (Master or House).

The returned information (via IE3R08) corresponds to the access rights of the specific EO for the particular entity – ENS, ENS filing or transport document (Master or House).

It is not possible to query information related to ENS filings which are not lodged by the requester. For example, the person filing a master level filing cannot request information related to an ENS filing submitted by a house level filer.

The returned information after the consultation of the ENS does not include the ENS filing content as such.

Example

A master ENS filing, for example F31, is submitted to ICS2 HTI. For some reason, the Declarant of F31 needs to retrieve the status of the processing of the ENS filing. In order to retrieve the history of the related in ICS2 information an ENS Consultation request (IE3Q05) is sent by the EO with the Transport document (Master level) reference and the related notifications requested. Then all related entities such as master consignment, ENS, ENS filing and their states are returned. In addition, as per the request the related notification are communicated back to the EO – IE3N01 ENS lifecycle validation error notification, IE3N02 ENS not complete notification, IE3N03 Assessment complete notification, IE3Q02 Additional information request, IE3N04 Additional information request notification, IE3N08 Control notification, IE3N09 AEO control notification, IE3N10 Amendment notification, IE3Q01 DNL, IE3R07 Invalidation acceptance response (whichever are applicable). Only the entities and the notifications related to the master ENS filing are retrieved and returned, the ones related to the linked house consignments are not returned.

5.3 Non-standard express scenarios

5.3.1 Force majeure circumstances for flights not initially planned to stop in ICS2 countries territory – handled by express

The force majeure circumstances could be of the following nature - technical, weather conditions, airport closures, emergencies, etc.

A flight from Kazakhstan to the USA, which crosses the ICS2 countries territory air space without stopover, gets grounded in the ICS2 countries territory due to force majeure circumstances. All consignments will have no pre-loading and pre-arrival ENS filings, hence none of the material on-board has been submitted for risk analysis. Decision is taken by the carrier either:

- To unload – forward the consignment to a warehouse – then presentation notification to customs is needed.
- Not to unload – consignment will not be unloaded from the aircraft or forwarded into the arrival ICS2 country – no presentation notification to customs is needed.
- To unload and transfer to another aircraft – consignment will not leave the ramp but will be transferred to another conveyance leaving the ICS2 countries territory. This is considered as unloading so there should be a presentation notification to customs. The exemption of the presentation is in the cases the goods are unloaded from the conveyance and then loaded back in order for other goods to be unloaded.
- In the event of diversion, the carrier to send an updated IE3N06 Arrival Notification with the new destination port and estimated arrival time.

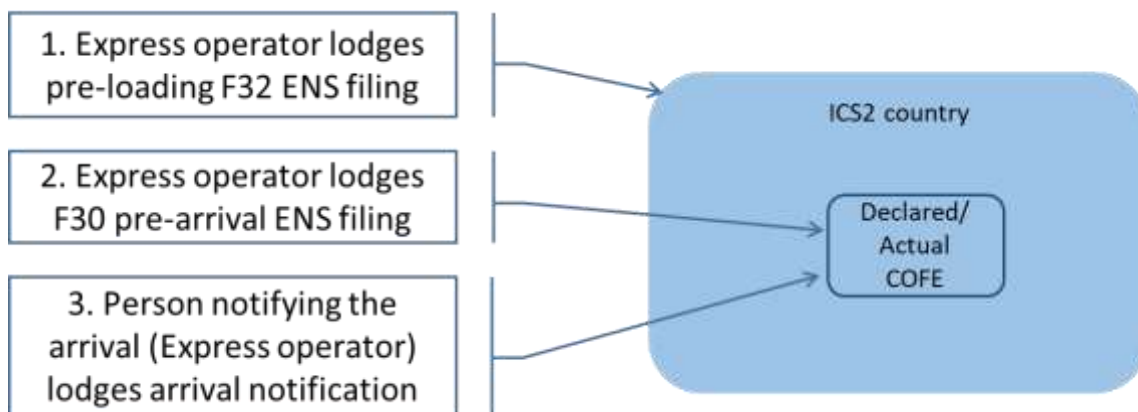

Table 5: Force majeure circumstances for flights not initially planned to stop in ICS2 countries territory - handled by express

Below is depicted a possible scenario from the perspective of entry of goods how to handle the diverted means of transport, not initially destined to an ICS2 country.

1. The express operator lodges F32 with the minimum dataset to the ICS2 country where the goods are expected to enter the ICS2 countries territory or already the means of transport has landed.
2. The express operator lodges a pre-arrival ENS filing F30 to the same country as above.
3. An Arrival notification is lodged in the airport of the COFE where the aircraft has landed – in case this takes place before the lodgement of the ENS then the contained reference in the Arrival notification should be the “Conveyance reference number” and the “Estimated date and time of arrival”.
4. A presentation notification (via national presentation system) is sent to the customs authorities where the goods are unloaded, if applicable.

The general rule is that the ENS (for both the pre-loading and the pre-arrival) should be lodged at the latest upon presentation. In case of force majeure circumstances the rules for the timelines for the ENS lodgement do not apply (Art. 111, UCC DA) but the obligation to lodge an ENS is not waived. Since all the information – both master and house – is available then the complete ENS filings can be used in case of air cargo general such as F20 and F28.

In case the goods are transported on air cargo general, the ENS can be lodged via the combination F32+F33+F21 or F32+F31 filings containing all the information. The scenario depicted above is just a possibility that does not exclude the use of the other two ENS filings combinations.

5.3.2 Loose loaded flight / bulk loading

A small aircraft from Albania to Italy contains only bags/packages. Pre-loading, pre-arrival and arrival customs processes are respected. In Italy all parcels are containerised in an ULD for further movement to France.

Where do the goods need to be presented, in Italy or at the final destination of the ULD in France?

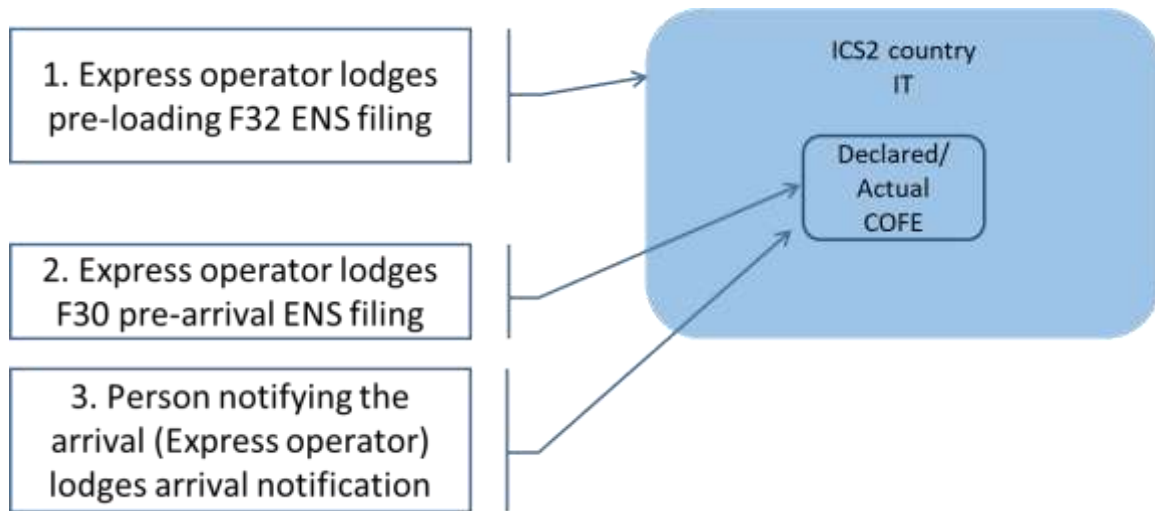

Table 6: Loose loaded flight / bulk loading

1. The express operator lodges F32 pre-loading with the minimum dataset to the ICS2 country where the goods are expected to enter the territory of the ICS2 country, in this case – Italy.
2. The express operator lodges a pre-arrival ENS filing F30 to the ICS2 country of the declared (expected) Customs Office of First Entry, in this case – Italy.
3. An Arrival notification is lodged in the airport of the COFE in Italy in this scenario.
4. A presentation notification (via national presentation system) is sent to the Italian customs authorities since the goods are unloaded there.

5.3.3 Re-entry of consignments into the territory of the ICS2 countries

In the following example, what is the process of submission of ENS filings: Consignment is transported from Beijing (CN) – Vienna (AT) – Cairo (EG) – Rome (IT). Does the EO need to submit:

- twice the pre-loading ENS and twice the pre-arrival ENS, indicating in the second pre-arrival ENS that this is re-entry or
- one pre-loading ENS and two pre-arrival ENSs with re-entry indicator set to “Yes”?

Please split the reply in if a) it is only one movement or b) when we have different movements.

Airway bill remains the same (if the re-entry then a problem), the shipment is unloaded/loaded/container transfer.

Scenario 1:

The combination of F32+F30 is considered for the example. The other ENS filings combinations are analogous.

The assumption here is that the route is known in advance and the Express carrier is aware the COFE is in Austria even if there will be exit and re-entry and a second COFE in Italy. The goods remain on-board in AT and in EG (no transshipment). In case the goods are unloaded and re-loaded to another aircraft then they must be presented to the customs authorities. Since there is no transshipment and the master transport document is the same then it is not needed to lodge pre-loading ENS filing (F32) again, but just the pre-arrival – F30 – with re-entry indicator as “True”.

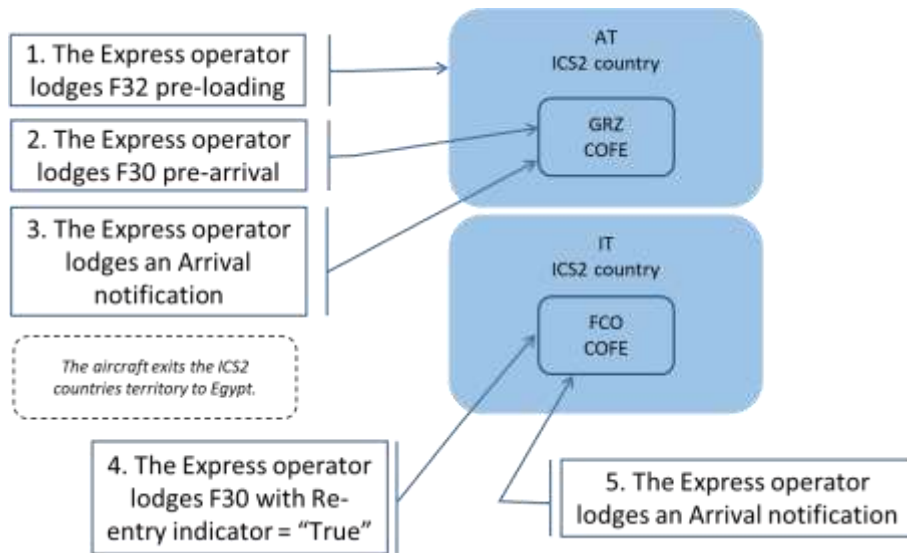

Table 7: Re-entry of consignments in ICS2 countries – a single movement

1. The express operator lodges F32 pre-loading with the minimum dataset to the ICS2 country (AMS) where the goods are expected to enter the territory of the ICS2 country for the first time – in this case AT.
 2. The express operator lodges a pre-arrival ENS filing F30 to the ICS2 country of the expected Customs Office of First Entry – in this case GRZ.
 3. An Arrival notification containing a reference to F30 is lodged in the airport of the actual COFE – GRZ.
- Then the aircraft exits the ICS2 countries territory to Egypt and is expected to re-enter in Italy, FCO.*
4. The express operator lodges a pre-arrival ENS filing F30 to the ICS2 country of the second Customs Office of First Entry with identical content of the first F30, identical master transport document, updated movement information and “Re-entry indicator” = “True” – in this case FCO.
 5. An Arrival notification containing a reference to the second F30 is lodged in the airport of the second COFE – FCO.
 6. A presentation notification is sent to the Customs authorities’ national presentation system where the goods are unloaded in Italy, FCO.

Scenario 2:

The assumption for this scenario is that the movement of the goods is covered by two master transport documents – one for the route CN -> AT -> EG and another one for EG -> IT. This is not an expected scenario since the goods destined to the ICS2 countries are expected to be unloaded during the first entry in AT. However, in case due to some reason the consignments are not unloaded, exit the ICS2 country, then they are unloaded in a 3rd country and are expected to be transported back to the ICS2 country via a new master transport document, then the pre-loading ENS (F32) has to be lodged.

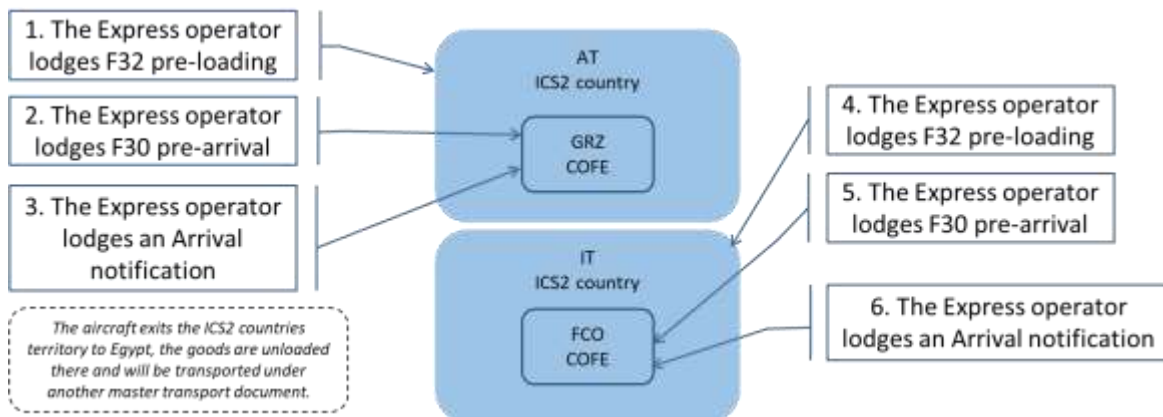

Table 8: Re-entry of consignments in ICS2 countries – two movements

1. The express operator lodges F32 pre-loading with the minimum dataset to the ICS2 country (AMS) where the goods are expected to enter the territory of the ICS2 country for the first time – in this case AT.
2. The express operator lodges a pre-arrival ENS filing F30 to the ICS2 country of the expected Customs Office of First Entry – in this case GRZ.
3. An Arrival notification containing a reference to F30 is lodged in the airport of the actual COFE – GRZ. (the goods were not unloaded)

The aircraft exits the ICS2 countries territory to Egypt, the goods are unloaded there and will be transported under another master transport document.

4. The express operator lodges a second F32 pre-loading with the minimum dataset to the ICS2 country (AMS) where the goods are expected to enter the territory of the ICS2 country for the first time – in this case IT – there the consignments will be brought back to the ICS2 territory.
5. The express operator lodges a pre-arrival ENS filing F30 with a new master transport document to the ICS2 country of the Customs Office of First Entry – in this case FCO.
6. An Arrival notification containing a reference to the new F30 is lodged in the airport of the COFE – FCO.

5.3.4 7. A presentation notification is sent to the Customs authorities' national presentation system where the goods are unloaded in Italy, FCO.A transit/stop of Union goods to a 3rd country

In case goods from an ICS2 country are destined to another ICS2 country but they stop in a 3rd country on the route then an ENS has to be lodged. For example, for goods from the NL destined to IE but there is a stop in the UK an ENS has to be lodged – both pre-loading and pre-arrival respecting the timelines as if the goods are loaded in the UK. All the expected data as if the goods come from a 3rd country should be provided such as the HS codes, etc.

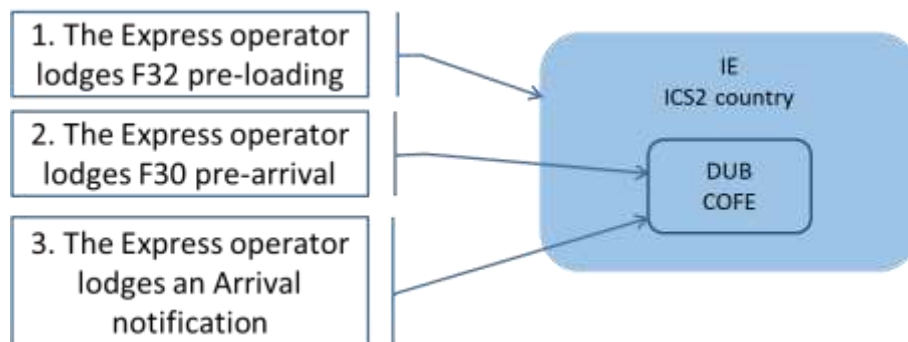

Table 9: Stop of ICS2 country goods in a 3rd country

1. The express operator lodges F32 pre-loading with the minimum dataset to the ICS2 country (AMS) where the goods are expected to re-enter the territory of the ICS2 country after the stop in the 3rd country – in this case IE.
2. The express operator lodges a pre-arrival ENS filing F30 to the ICS2 country of the expected Customs Office of First Entry – in this case DUB – where the goods from NL will re-enter the ICS2 territory.
3. An Arrival notification containing a reference to F30 is lodged in the airport of the actual COFE – DUB.
4. A presentation notification is sent to the Customs authorities' national presentation system where the goods are unloaded in Ireland, DUB.

6 DATA REQUIREMENTS

6.1 Linking on ENS filings into an ENS

When an ENS is filed using the multiple partial ENS filings (F21 and F33), those filings are linked into an ENS using the following mechanism.

F21 is linked to the corresponding F33 based on the correspondence of the data elements values in both ENS filings depicted below. The combination of the “Master transport document reference number” and the Carrier EORI in both F33 and F21 should be identical. The Declarant EORI of F33 should be specified as a supplementary house level declarant in F21.

F33		F21
Master transport document reference number x	}	Master transport document reference number x
Carrier EORI y		Carrier EORI y
<u>Declarant EORI z</u>	=	Supplementary declarant EORI = <u>Declarant EORI z</u>
		Supplementary declarant type = 1 (House level filing)

Table 10: Unique linking key between F21 and F33

In addition, each house consignment from the pre-loading ENS filing (f32) is associated with the respective House consignment in the F33 filing in order to create a link of the pre-loading risk analysis results with the ENS in the pre-arrival phase. The association is done as described below.

Each house consignment is uniquely identified for 12 months based on the combination of the “Transport document (House level) / Reference number” and the “Consignment (House level) / Reference number/UCR”. Each house consignment in the F32 ENS filings is associated with the corresponding house consignment in F30/F31/F33 filing based on the same declarant EORI for both ENS filings and the identification of each house consignment based on the combination of the “Transport document (House level) / Reference number” and the “Consignment (House level) / Reference number/UCR”. In case the declarant of F30/F31/F33 and F32 is not the same, no linking is possible.

F32		F30/F31/F33
House consignment Transport document reference number x	}	House consignment Transport document reference number m
House consignment UCR y		House consignment UCR n
...		
House consignment Transport document reference number m	}	House consignment Transport document reference number t
House consignment UCR n		House consignment UCR z
...		
House consignment Transport document reference number t	}	House consignment Transport document reference number x
House consignment UCR z		House consignment UCR y

Declarant EORI u	=	Declarant EORI u
------------------	---	------------------

Table 11: Linking between the house consignments in the pre-loading and the pre-arrival ENS filings for express consignments

6.2 Data consolidation on master level

In case of F31, where the cargo at master level is consolidated from many underlying house consignments, the description of goods at master level can be replaced by the statement 'detailed goods description as provided from the house level', provided that the detailed information is filed on the house level. In case the detailed house level information is not provided, the carrier will be requested to amend the ENS filing, e.g. via the referral process.

Regarding the commodity code, there should not be used any sort of dummy or invented code, but the HS code of one of the goods part of the consignments. The indicated weight at the consolidated master level must be the gross mass of all transported house consignments under the particular master transport document. The "Packaging" should be populated with the information considered most relevant for the indicated commodity code. In case there are containers they can be listed directly under the master level information, not in the goods item.

Regarding the detailed information for each goods item declared on the house level, it must be provided without any sort of consolidation.

6.3 Definition of data elements

	Data element name	Definition
1	Re-entry indicator	This indicator in F30 and F31 (master ENS filings) is to be used when goods, for which ENS was already lodged upon their first entry into the territory of the ICS2 countries, are again entering the territory of the ICS2 countries under the same master transport document and not having left the means of transport (no transshipment).
2	Split Consignment	The use of the "Split consignment" in F30 and F31 (master ENS filings) is envisaged for the cases when due to some reason the goods cannot be transported on the initially planned means of transport. The content of the initially submitted ENS filing and the subsequent one(s) with "Split consignment indicator" as "True" should not differ (not different house consignments to be included), only the transport related information to be updated accordingly.
3	Type of person	Natural person, legal person or association of persons. Needs to be indicated for the relevant party in the ENS filing.
4	Countries of routing of the means of transport	All countries, which conveyance crosses, on the route to the destination in the ICS2 countries. As per the rules in the HTI specifications [R01] – the first ICS2 country is the COFE (R3018), the country of the place of loading is the first country in the sequence (R3013) and the country of the place of unloading is the last country from the sequence (R3014).
5	Countries of routing of the consignment	The routing of the consignment can differ from the routing of the means of transport since before being transported with the latest conveyance entering the ICS2 countries it can be previously transported via different countries. Same applies to the countries after the unloading from the means of transport. As per the rules in the HTI specifications [R01] – the countries of the place of delivery and the place of acceptance should be part of the countries of routing of the consignment (R3022).

6	Transport charges / Method of payment	The method of payment for the transport charges (CL116 – payment in cash, by credit card, electronic funds transfer etc.). Only the method of payment is indicated, not the amount of the charges.
7	Place of Delivery	The place where the goods from the house consignment are to be delivered to the consignee. Either an encoded UN/LOCODE or a free text location in a country is provided.
8	Place of Acceptance	The place where the goods are accepted by the express carrier for the transportation. Either an encoded UN/LOCODE or a free text location in a country is provided.
9	Transport equipment	The identification of the container where the goods are transported in case containers are used. In such case the “Container indicator” should be filled in as “True”.
10	Total gross mass	The total mass of the goods with all packing materials provided either at house consignment or at master consignment level.
11	Supplementary declarant	Any other person expected to lodge partial house level ENS filings, besides the main declarants (as express carrier), e.g. freight forwarder, consolidator, etc.
12	Reference number/UCR	Unique consignment reference number assigned by the express operator to the consignment. It is mandatory on house consignment level and is used in combination with the house level transport document reference number to uniquely identify the house consignment.
13	Packaging	This data element relates to details of the packaging of the goods subject to the declaration or notification. The packaging information consists of the following information number of packages, type of packages in CL017 (for pre-arrival) and the shipping marks (if relevant).
14	Shipping marks	Free form of description of the marks and numbers on transport units or packages to allow the easier identification of a particular box/package. This information will only be provided for packaged goods where applicable. Where goods are containerized, the container number can replace the shipping marks, which can however be provided by the economic operator where available. A UCR or the references in the transport document that allows the unambiguous identification of all packages in the consignment may replace the shipping marks.

Table 12: Data elements definitions

6.4 Missing and incorrect data elements

In case the data of the submitted express filings F30, F31, F32 and F33 are not valid as per the defined syntactic and semantic rules, the ENS filings are rejected via IE3N99 Error notification or IE3N01 ENS lifecycle validation error notification. The ENS filing is in status “Rejected” and is not considered as registered/accepted by the customs authorities. The needed corrections to the ENS filing should be made and the ENS filing should be re-submitted within the expected time limits.

The possible reasons for the rejection could be a missing mandatory data, code list violation, format violation, etc. There are uniqueness checks performed for the used LRN, master transport document reference, the house consignment identifier (House consignment transport document reference and UCR combination) which can also result in the rejection of the ENS filing.

In addition, as of R2 the data quality and data consistency checks are enhanced and some further verifications will be performed as elaborated further in this section. If the quality of the provided data is low then the ENS

filing can be rejected as well. In case the ENS filing data is provided in an encoding different from Latin, Cyrillic or Greek, then it is automatically rejected.

6.5 Poor data quality examples

In ICS2 R2 the verification of the data quality is enhanced so the ENS filings can be rejected due to poor data quality even if they are successfully validated for syntactic and semantic errors. In case the quality of the provided data is very low, then the ENS filing will be rejected via IE3N99 Error notification with the error 100 "Not satisfactory data quality".

Below are examples of data elements filled in which will be treated as empty after the check of the data quality:

1. Goods description – unacceptable goods descriptions - terms too vague, not in line with the guidance such as "not specified", "goods description", etc.:

Example (of poor quality data):

```
[...]
<goodsItemNumber>1</goodsItemNumber>
<postalValue currency="GBP" value="0.00"/>
<typeOfGoods>11</typeOfGoods>
<commodity>
  <descriptionOfGoods>Not Specified</descriptionOfGoods>
</commodity>
```

[...]

2. Party names - 'Not Specified', 'Unknown', 'Consignee Name', 'Consignor name', 'N/A' etc.:

Example (of poor quality data):

```
[...]
<consignee>
  <name>Consignee Name</name>
  <address>
```

[...]

3. Address:

- Address/Number – if provided, the street number is submitted together with street name, in the street name line 1 field, while in the street number field is filed with '9999999999';

- In the absence of the number in the address, 'N/A' should be provided;

- When number is provided together with the street name, it should also be provided in the street number.

Example (of poor quality data):

```
[...]
<address>
  <city>KLAIP DA</city>
  <country>LT</country>
  <subDivision>KLAIP DA</subDivision>
  <streetNameLine1>19-7 J. ZAUERVEINO GATV;KLAIP DA</streetNameLine1>
  <postCode>92122</postCode>
  <number>99999999999999999999999999999999</number>
</address>
```

[...]

[...]

```
<address>
  <city>Not Specified</city>
  <country>FR</country>
  <subDivision>Not Specified</subDivision>
  <streetNameLine1>LIEU PIT ST QUENTIN;Not Specified</streetNameLine1>
  <postCode>47330</postCode>
  <number>99999999999999999999999999999999</number>
```

</address>

[...]

6.6 Data consistency checks

The data consistency checks compare the values for certain data elements provided by the carrier on master level in the ENS to the corresponding values provided on house consignment level. In case of a certain level of mismatch, the NES performing the risk analysis is notified and further checks and controls/referrals can follow for the economic operator. The data consistency checks cannot result in automatic rejection of the ENS filing. The below data elements are cross-checked:

1. **Containers/Transport equipment** – the identifiers of the containers indicated on master level are expected to match the identifiers of the containers provided on house level.
2. **Gross mass** – the gross mass indicated on a master level should equal the sum of the gross masses indicated in the linked house consignments.

The sum of the gross mass indicated for each of the house consignments is compared to the total gross mass filled in on a master level. Even if there is gross mass indicated on item level (both on master and house) it is not considered as part of the consistency check.

7 TRANSITION FROM ICS2 R1 TO R2

During ICS2 R1 the pre-arrival phase is covered by ICS1 and pre-loading phase is covered by ICS2.

Transition of the pre-loading ENS filings from R1 to R2 has 2 aspects:

- Change of the message version of F32 from R1 to R2, which needs to be done during switch-over period;
- Change of the place where the ENS filing (F32) has to be addressed.

Switch-over of express operators –the express operators will choose a short switch-over window, e.g. 1 – 2 days up to one week for the switch-over. The express operators need to finalize all transactions initiated in ICS2 R1 (R1 version of the messages) with R1 response messages. This finalization means that open referrals are answered, the air pre-loading risk analysis is completed and ‘Assessment Complete notification’ or ‘Do Not Load request’ are communicated via R1 version of the messages. After this is done, the new pre-loading ENS filings (F32) will be lodged in R2 version of the messages.

Change of the place where ENS has to be lodged will be done at the latest by the 1 March 2024. Until this change is implemented, the express operators will file the pre-loading ENS filings (F32) to the MS where their main EU hub is located. After the change the pre-loading ENS filings (F32) will be filed in the MS where the anticipated COFE is located.

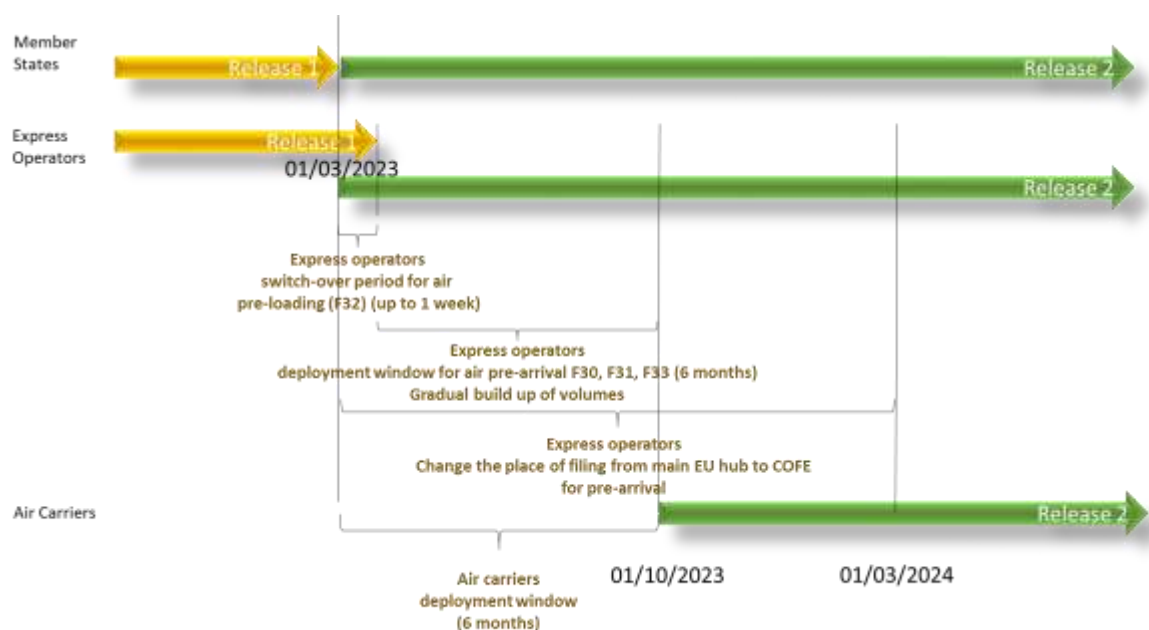

Figure 14: Express switch-over period and deployment windows and air carrier deployment window

Transition of the pre-arrival ENS filings into ICS2 R2 will be organised within the deployment window that can be granted to the express operators and the air carriers. Until the pre-arrival ENS filings are not lodged to ICS2 R2, the pre-arrival data is lodged in ICS1.

Deployment window for the express operators – to ensure the smooth migration of the express operators a deployment window of up to 6 months can be granted for the lodgement of the pre-arrival ENS filings (F30, F31 and F33). The pre-arrival ENS filing types for the express consignments are planned to be lodged gradually building up volumes per country. Since lodgement of F30 and F31 ENS filings is done in the form of the full ENS filing and no other party is involved, the express operators can do a gradual roll out within the granted deployment window. The lodgement of F33 ENS filings (in combination with F21) for the express consignments on air cargo general is possible only after the air carriers connect to ICS2 and are able to file F21 ENS filings. For the express consignments on air cargo general, if the carriers are not yet connected then the express operators are expected to lodge F31 with the master level transport information or to lodge the pre-arrival information in ICS1.

Deployment window for the air carriers for express consignments on air cargo general – a deployment window for up to 6 months can be granted to the air carriers to connect to the ICS2. In general, this window can be used for both ENS filings for air cargo general and express consignments on air cargo general to be filed in ICS2. Until the air carriers connect, the express operators can only file full ENS filings (F31) for express consignments on air cargo general.

8 BUSINESS CONTINUITY

In case unavailability of an electronically supported business process happens, as:

- a relevant electronic system of the economic operator is unavailable;
- a relevant electronic national customs application or supporting system is unavailable;
- a relevant central component service is unavailable,

the express operator is expected to apply the commonly agreed procedures elaborated in the Business continuity plan [R02].

9 QUESTIONS AND ANSWERS

Question 1:

New sub-processes (executed by STI) are included as of Release 2: Cleanse ENS filling, Check stop words/phrases and Check data consistency. What are the predefined rules, algorithms and reference data agreed?

Answer:

As of ICS2 Release 1 Member States have the first real experience with the ENS's. The feedback we have received is that data quality in ENS's is poor and should be improved. These processes are implemented for ENS's, e.g. with no meaningful information in it, to be rejected.

As long as all information as requested by legislation is provided in the ENS, the message validation will be successful. Nevertheless, if the data quality in the ENS is poor, it is possible that ENS could be rejected or referrals for additional information requests or requests to amend ENS could be issued for those ENS's.

Rules, algorithms and reference data will be defined and will be updated upon such a necessity. This information will not be disclosed to EO's.

Question 2:

What would be the RMS/IMS principle in ICS2 R2 (pre-arrival)?

Answer:

For pre-arrival risk analysis, the RMS should be the Member State where it is anticipated that consignment will actually enter customs territory of European Union (determined from customs office of the first entry declared). IMS will be determined on the basis of information provided in ENS, e.g. country of consignor, consignee, carrier, routing of means of transports and consignments and other.

Question 3:

Is there AC notification foreseen to be sent to the EO after risk analysis is completed on full ENS (at the pre-arrival stage)? What if the risk analysis is not completed at the time shipments arrive in the EU?

Answer:

Yes, assessment complete notifications will be sent after pre-loading and pre-arrival risk analysis. After pre-loading the assessment complete notification is sent per house consignment, whereas after pre-arrival it is sent per ENS.

Normally, MS would finalise risk analysis within the deadlines defined in the legislation and make a decision whether to perform controls or not. However, if the risk assessment process is not finalised due to e.g. open referrals, then the cargo will not be released for subsequent procedure until customs finalise risk assessment.

Question 4:

Under the "ENS Ready for full risk analysis" process in ICS2-HTI-BPML3.5-(2021-07-30)-v2.00 document and according to "Sub-process HLS003: Perform risk analysis", once the ENS is ready for full risk analysis and the risk analysis is completed there are two outcomes:

- Set control recommendation and place of control, and send AC notification or
- Issue DNL

In most cases an ENS would be ready for full risk analysis at the pre-arrival stage. Hence, does it mean that EO can receive at that stage either AC and Control Notifications or DNL request? Based on which type of ENS this process is triggered?

Answer:

Please use BPML4 when analysing business processes for ICS2 Release 2 as much as possible.

The DNL after the full RA (pre-arrival) process is designated for maritime cargo. For air cargo the declarant will receive AC message followed by an advanced control notification, if it holds AEOS status. If this is not the case, control notification can be received only after arrival notification is lodged, in case of very high risk, or after the presentation of goods. After the presentation of the goods the controls are communicated not via ICS2 but via the national presentation system.

Question 5:

Under the “Manage timer for completion of risk analysis” process in ICS2-HTI-BPML3.5-(2021-07-30)-v2.00 document the following Express ENS declarations are missing: F31, F33 and F34 (road). Is there any specific reason for that?

Answer:

BPML3.5 contain only high level business processes for ICS2 Release 2 and we were mainly focusing on processes described in BPML4 when HTI was updated. It is possible that we have missed something in BPML3.5, so please use BPML4 when analysing business processes for ICS2 Release 2 as much as possible.

This issue identified by you is noted and we will fix it in the next version of the document.

Question 6:

What is the difference between RFI request (IE3Q02) and RFI notification (IE3N04)? The same, what is the difference between RFS request (IE3Q03) and RFS notification (IE3N05)?

Answer:

IE3Q02 and IE3Q03 are referral requests sent to the declarant and the EO, who has received this request, is obliged to provide responses (IE3R02, IE3R03 or IE3Axx) to these requests.

The referral notifications IE3N04 and IE3N05 are sent to the carrier (indicated in ENS) for information purposes only. Upon the receipt of such a notification, the carrier can plan its activities as well, e.g. make the goods available for HRCM screening if the goods are already handed over to the carrier.

Question 7:

Could you please provide further clarification, from ICS2 point of view, on the implementation of Art. 189 UCC IA in case of diversion of an aircraft entering the custom territory of the Union?

Answer:

In case of diversion, the economic operator should indicate the actual customs office of first entry (ACOFE) in the arrival notification.

There is nothing more the economic operators should do in this case, as ENS and control recommendations will be communicated to the ACOFE by ICS2 Common repository.

Question 8:

The arrival notification need to be submitted in the FCOE (COFE). Does it also need to be submitted in a subsequent port or will the presentation notification be sufficient?

Answer:

You should not submit arrival notification in a subsequent port. The Arrival notification should be submitted in ICS2 or in the national arrival system (developed and maintained by a particular MS/customs office only) in the customs office of the first entry only. In all the subsequent port(s) goods should be presented when unloaded to customs to finalise the entry formalities.

In case the means of transport exits and re-enters the ICS2 countries territories then another Arrival notification is needed to be lodged to the second COFE.

Question 9:

In case one of the below notifications are sent out to the EO, what happens then? Could you please elaborate further and provide clarification on the use of the following messages:

- IE3N07 (House consignment in incorrect state notification);
- IE3N11 (ENS pending notification);
- IE3N02 (ENS Not complete notification)?

Answer:

IE3N07 – upon arrival the carrier or the person notifying arrival should lodge arrival notification (IE3N06) in the ICS2 or by using services provided by the Member State, where consignments have actually entered the customs territory of the ICS2 country. IE3N06 is registered and then validated. One of the validations applied is to check the state of house consignments (HC) from the related ENS. If a HC is already in the state ‘Presented’ or ‘Controlled’ the person notifying the arrival will receive IE3N07 with details which HC is in incorrect state. For this HC it is not possible to change the state to ‘Arrived’.

Once you have received such a message you are expected to investigate whether the HC has been actually presented or controlled and if this is not the case you can involve MS or other involved supply chain partners in further investigations (if necessary).

Full ENS can consist of one master level ENS filing and one or several house level ENS filings. Normally the house level ENS filings are lodged before the master level ENS filing is lodged. Nevertheless it can happen that e.g. one house level ENS filing is not lodged and the ENS cannot be composed. In such case:

- IE3N11 will be sent to person that has not filed yet as a reminder to lodge the missing ENS filing. This can happen in the cases of the combination of F32+F33+F21 when the express operator has not lodged the expected F33;
- IE3N02 will be sent to master level ENS filer for information that ENS is not complete; (this is not relevant to the express operators)
- and pre-arrival risk analysis will be triggered by ICS2.

The person filing, who has not filed yet, is identified based on the supplementary declarant indicated in the upper level master ENS filing (F21).

Question 10:

With regards to the message sequence, when an EO could expect to receive the control notifications (IE3N08/IE3N09) - after the complete ENS is lodged or after AN is registered?

Answer:

In case EO holds AEOS status, it can expect to receive IE3N09 after an assessment complete notification is received. If the EO does not hold AEOS status, then IE3N08 can be expected after the arrival is notified to customs (in case a very high risk is identified).

Question 11:

If there are no controls decided, how the EO will be informed and which message will be sent to him?

Answer:

During risk analysis different risks can be identified and different measures can be taken to address these risks. Therefore, for customs there is also some flexibility to decide what controls and when should be performed.

For example, during the pre-arrival risk analysis very high risk is identified requiring immediate controls upon arrival. In this case, customs office will send you a control notification (IE3N08 or IE3N09) and you will be required to present the goods for control at COFE even if the goods were not supposed to be unloaded at this office. Meantime, it is also possible that only some regular risks have been identified during pre-arrival risk analysis not requiring immediate action at customs office of the first entry. In this case, MS of presentation/MS of unloading would inform you about controls upon presentation only and on these controls you will be notified outside ICS2.

Question 12:

In accordance with second paragraph of art. 24 (4) UCC, an AEO holder could request that the controls may be carried out at a place other than the place where the goods have to be presented to customs. Could you please explain how this is implemented within the ICS2 R2 business scope?

Answer:

The place of control is not in the scope of ICS2. This question needs to be addressed to the national customs authorities.

Question 13:

Even it is part of the ICS2 business process scope, the presentation of goods and the related notification should be submitted to the national systems. Therefore, could you please provide further information about the interoperability between ICS2 Release 2 and the national UCC Notification of Arrival, Presentation Notification and Temporary Storage systems, including current progress and MS readiness.

Answer:

Since Presentation Notification and Temporary Storage systems are exclusively Member state competence and are not in scope of ICS2, you should contact Member State customs authorities to obtain all relevant information.

Question 14:

Will the control results be communicated back to the EO?

Answer:

No. The communication of the control results to the EO is not in the scope of ICS2. You can check this with your national authorities, perhaps it is under the scope of their national presentation or control systems.

Question 15:

Will we get a release message after completion of a physical inspection on a shipment?

Answer:

Sending of such a message is not under the scope of ICS2. This question can be addressed to the national customs authorities.

Question 16:

What and who could trigger an ENS Consultation process (IE3Q05)?

Answer:

ENS consultation can be triggered by any Declarant or Representative.

The main purpose of ENS consultation request is to get information (e.g. entire history) what has happened with the particular ENS and what is its current state. ENS consultation can be triggered in case e.g. you have lost or have not received some notifications from ICS2 and you are not aware of the current ENS state. The ENS states are defined in code list CL744 State code and can be e.g. accepted, arrived, invalidated.

Question 17:

For the future, EEA will be obliged if the EU Commission provides, in advance, information on any planned updates of the specifications and also invites trade associations to participate in the discussion before the approval of such changes. It is crucial for us to be aware of all modifications proposed as soon as the discussion starts.

Answer:

Any changes in ICS2 specifications having impact to Economic operators and/or Member states are first approved by ICS2 Change advisory board (CAB) before implementation starts. Proposed changes are sent out to TCG for consultation before CAB meeting takes place. The final decision is taken by the CAB. Once the CAB has made a decision to implement changes and by when to implement them, a new version of HTI is drafted and sent out to Trade.

In case misalignments (minor corrections) are found, then a known error is registered in the Known Error List which is published for information to the EO's. It is indicated where the correction is to be implemented and as of which version of the HTI specifications.

Question 18:

In the situation that an EO is not able to provide certain mandatory data element as of 01 March 2023, is there a possibility of a grace period until the end of the deployment window? Furthermore, if there are serious, notified, difficulties with transmitting the mandatory data elements by the end of the grace period can consideration be given to extending the grace period for a defined, limited, time period.

Answer:

No, as soon as you have deployed ICS2 Release 2 functionality you have to be able to provide the information requested and especially the information in the mandatory data elements. If this is not possible for you as of 01.03.2023, you can request your MS of registration to grant you with the deployment window as per Transition from R1 to R2 strategy. By the end of deployment window you should be able to comply with the requirements of ICS2 Release 2.

Question 19:

Is the split consignment indicator usage the same for postal shipments as for cargo (meaning fully report PAWB with all House consignments (=receptacles), and in any further flights F42 is resubmitted with split consignment indicator and full list of receptacles)?

Answer:

Yes, the principles how to use split consignment indicator are the same for postal shipments and for air cargo general.

Question 20:

Is it really: referral is issued “either to postal operator at destination, or carrier”? Or should it read “postal operator **AND** carrier”? If it is OR: how do you differentiate? When does it go to who? In practice, carrier will not be able to answer RFI for postal, as only postal operator has full data for shipment. For carriers, a standard process would be preferable: it is always postal AND carrier.

Answer:

The general principle for issuing a referral request is that it is sent to the party who has lodged a particular ENS filing. Meaning, if the RMS issues a referral request for a house level ENS filing, the postal operator (or any other house filer) will be obliged to provide response and carrier will get notification that referral request was issued. Nevertheless, in case the RMS issues a referral request in pre-arrival risk analysis phase and indicates the Master transport document in the corresponding referral request, then the carrier will be the one obliged to provide the response. In this case the postal operator will not be notified that such a request was issued.

Question 21:

The split consignment indicator is mandatory, however, airlines do not have this information prior to loading. Split is mostly done at the time of loading and PLACI data need to be sent prior to loading. Is it always going to be Total?

Answer:

Yes, split consignment indicator is mandatory data element but possible values are YES/NO so there should not be a problem to lodge ENS because of that.

First, you lodge the ENS with split consignment indicator ‘NO’. In case e.g. consignment does not fit on the plane and will be split (part of it will be delivered with another plane), you will keep the same MAWB. Before the remaining part of the cargo arrives to the EU, you need to lodge another ENS with the same MAWB as in the original ENS, but this time you need to set split consignment indicator to ‘YES’. The information for the consignments will be the same as for the original ENS, except for the information on the active means of transport such as the routing, departure/arrival times, etc.

If two ENS’s are lodged with the same MAWB and without setting the split consignment indicator to ‘True’ for the second ENS filing, it will be rejected due to the violation of the data uniqueness rules.

Question 22:

What happens if the House consignment has been PLACI filed by Forwarder and carrier files it again (not knowing)? Error? Or will we then receive original MRN/Assessment complete?

Answer:

Both filings will be treated separately in the pre-loading phase.

For forwarder and carrier filing house level information the process will be as usual, meaning:

- each ENS filing will be validated;
- if there is no error in the filing it will be accepted and an MRN will be assigned (each ENS filing will have its own MRN);
- the pre-loading risk analysis will be performed;
- an assessment complete notification or a Do Not Load request will be sent to the person filing and the carrier, if any, indicated in the corresponding ENS filing.

Question 23:

Out of multiple MRN’s received in ICS2 process (PLACI, Pre-arrival, arrival) which one do we use for local temporary storage procedure (after ICS)?

Answer:

An ENS can be filed using:

- one filing containing house and master level information (full filing);

- consolidated from multiple ENS filings - one master level ENS filing and one or several house level ENS filings.

Therefore, during the ICS2 process there could be more than one MRN assigned, but it is important to understand that for the ENS there is only one MRN and it is the MRN of the master level ENS filing. Which MRN should be used for temporary storage procedure is not ICS2 related question. To be on the safe side you could use MRN of ENS (master level filing) but please address this question to customs office where you intend to initiate the temporary storage procedure.

The Arrival notification has an MRN, but it is not linked to any ENS. It cannot be used to identify an ENS.

Question 24:

The IE3F4x series of messages (Postal Filings) do not seem to request information related to the screening method (HRCM screening results), while this request is present in the IE3F20 (Air Cargo Filing). What is the reasoning behind this difference?

Answer:

According to the information provided by the postal operators, HRCM screening for postal consignments is never done at this stage without request. For postal consignments the house level declarant is always located in an ICS2 country and it will not request to perform HRCM screening without a prior request from customs. Therefore, in IE3F4x this information could not be provided and this is the reason why this data class is not included in the IE3F4x messages.

At the same time, for other consignments it is possible that HRCM screening is already performed in advance and if this is the case it can be provided in IE3Fxx to prevent referral requests from customs.

Question 25:

Mode of Transport is mandatory but only available in IATA Cargo-XML, not Cargo-IMP. This may be an issue for carriers who are still using IATA Cargo-IMP.

Answer:

All the mandatory information should be provided by the EO upon the go-live of ICS2 Release 2. If the EO is not able to provide this information as of 01.03.2023 it can ask its Member State of registration to provide it with a deployment window in line with the Transition from Release 1 to Release 2 strategy.

Question 26:

For the Consignment (Master level), the Container indicator is mandatory. What is the expected value?

Answer:

Yes, the data element is mandatory and you need to indicate (use code from code list CL708) whether:

- 0 - Goods not transported in containers;
- 1 - Goods transported in containers.

In case you are transporting containerised cargo you will use code list value '1' and will provide details on the container(s) (transport equipment) used to transport the consignments.

Question 27:

For the Consignee, the Type of person is mandatory. However, it is not available in IATA messaging/business standards. How should we handle this element?

Answer:

The requirement to indicate the type of person is included in UCC DA and in order to comply with the legal requirements you need to update IATA messaging/business standards to include the type of person and, consequently, you need to request this information from your clients.

As a workaround, you could indicate "Legal person" for all the consignees as a temporary solution.

Question 28:

For the Packaging -> Type of packages, this information is indicated as mandatory. However, it is not available in the air cargo industry and not available in messaging/business standards.

Same question for "Shipping Marks" and "Number of Packages": what is expected there?

Answer:

The requirement to indicate the type of packages is included in UCC DA and in order to comply with the legal requirements you need to update IATA messaging/business standards to include the type of packages and, consequently, you need to request this information from your clients. The same stands for “Shipping Marks” and “Number of Packages”.

Question 29:

Please elaborate on requirements on EO side regarding referral handling. The operational guideline states that EO should provide single point of contact and 24/7 availability for each type of referral. What is the purpose behind this? Referrals will be received via system. Is the single point of contact then for urgent/unusual requests?

From carrier point of view, we will need origin station and/or customer to reply to some referrals. Not all stations are manned 24/7. And if we depend on customer feedback, that will definitely not be available 24/7.

Answer:

The 24/7 central contact point is extremely important for the DNL handling. The DNL request will be sent via the system, in addition, the DNL protocols will be triggered and communication will be done via alternative communication channels in parallel. As regards the other referral types, such communication channel is needed in case more information needs to be provided by the customs authority to the EO which is not exchanged via the system, e.g. reasons for specific HRCM screening method to be applied. Refer to [R06].

Question 30:

In case of force majeure circumstances when there are express consignments transported on a plane that is not planned to land in ICS2 countries, the plane needs to land an ENS is needed. However, the express carriers/air cargo general carriers may not have the full detail of the information expected to be lodged to ICS2 – which ENS filings should be lodged and what principles need to be followed?

Answer:

In case of force majeure circumstances for goods originally not destined to enter the ICS2 countries the ENS both pre-loading and pre-arrival has to be lodged. The applicable legal timelines for the lodgement of the pre-loading and the pre-arrival ENS filings may not be respected – at the latest upon the presentation of the goods.

Question 31:

The HS Code is mandatory when at least one of the parties in the consignment is not an individual. In case of express consignments – what happens if the HS code is not provided on house consignment level if the Consignor : Consignee is private person to private person. However, at master level the parties between which the goods are exchanged are legal entities (express operator, etc.), then how the HS code is expected to be found out? This is applicable not only for the express consignments, but for other consignments on air cargo general as well.

Answer:

THE HS CODE HAS TO BE PROVIDED ON A MASTER LEVEL BY THE EXPRESS OPERATORS ONLY IN F31 – THERE A CONSOLIDATION OF GOODS ITEMS INFORMATION IS POSSIBLE SO PLEASE REFER TO 6.2 Data consolidation on master level.

End of document